

TECHNICAL MANUAL
DIRECT SUPPORT AND GENERAL SUPPORT
MAINTENANCE MANUAL
FOR
MILITARY PYROTECHNICS

DISTRIBUTION STATEMENT A: Approved for public release; distribution is unlimited.

HEADQUARTERS, DEPARTMENT OF THE ARMY

MARCH 1996

CHANGE)
)
NO. 5)

HEADQUARTERS
DEPARTMENT OF THE ARMY
WASHINGTON, DC, 1 November 2007

**Direct Support and General Support Maintenance Manual
for
Military Pyrotechnics**

DISTRIBUTION STATEMENT A - Approved for public release; distribution is unlimited.

TM 9-1370-203-34, 5 March 1996, is changed as follows:

1. File this change sheet in front of the publication for reference purposes.
2. Remove old pages and insert new pages as indicated below.
3. New or changed material is indicated by a vertical bar in the outer margin of the page.
4. Added or revised illustrations are indicated by a vertical bar adjacent to the illustration identification number.

Remove Pages

A and B
4-13 and 4-14
4-17 and 4-18
D-7 and D-8

Insert Pages

A and B
4-13 and 4-14
4-17 and 4-18
D-7 and D-8

By Order of the Secretary of the Army:

Official:



JOYCE E. MORROW

*Administrative Assistant to the
Secretary of the Army*

0729005

GEORGE W. CASEY, JR.
*General, United States Army
Chief of Staff*

DISTRIBUTION: To be distributed in accordance with the initial distribution number (IDN) 400322 requirements for TM 9-1370-203-34.

CHANGE)
)
NO. 4)

HEADQUARTERS
DEPARTMENT OF THE ARMY
WASHINGTON, DC, 14 September 2006

**Direct Support and General Support Maintenance Manual
for
Military Pyrotechnics**

DISTRIBUTION STATEMENT A - Approved for public release; distribution is unlimited.

TM 9-1370-203-34, 5 March 1996, is changed as follows:

1. File this change sheet in front of the publication for reference purposes.
2. Remove old pages and insert new pages as indicated below.
3. New or changed material is indicated by a vertical bar in the outer margin of the page.

Remove Pages

A and B
1-1 and 1-2
A-1 and A-2
B-5 and B-6
D-7 and D-8

Insert Pages

A and B
1-1 and 1-2
A-1 thru A-4
B-5 and B-6
D-7 and D-8

By Order of the Secretary of the Army:

Official:



JOYCE E. MORROW
*Administrative Assistant to the
Secretary of the Army*
0624803

PETER J. SCHOOMAKER
*General, United States Army
Chief of Staff*

DISTRIBUTION: To be distributed in accordance with the initial distribution number (IDN) 400322 requirements for TM 9-1370-203-34.

CHANGE

NO. 3

**HEADQUARTERS
DEPARTMENT OF THE ARMY
Washington, DC, 30 January 2004**

**TECHNICAL MANUAL
DIRECT SUPPORT AND GENERAL SUPPORT
MAINTENANCE MANUAL
FOR
MILITARY PYROTECHNICS**

DISTRIBUTION STATEMENT A: Approved for public release; distribution is unlimited.

TM 9-1370-203-34, dated 05 March 1996 is changed as follows:

1. File this change sheet in front of the publication for reference purposes.
2. Remove old pages and insert new pages as indicated below.
3. New or changed material is indicated by a vertical bar in the outer margin of the page.
4. Added or revised illustrations are indicated by a vertical bar adjacent to the illustration identification number.
5. Added or revised appendixes are indicated by a vertical bar adjacent to the appendix title.

Remove pages

A and B
i thru iv
3-5 and 3-6
4-13 thru 4-18
A-1 thru A-4
B-1 thru B-8
D-3 and D-4
D-7 and D-8
DA 2028-2

Insert pages

A and B
i thru iv
3-5 and 3-6
4-13 thru 4-20
A-1 and A-2
B-1 thru B-8
D-3 and D-4
D-7 and D-8
DA 2028

File this change sheet in front of the publication for reference purposes.

By Order of the Secretary of the Army:

PETER J. SCHOOMAKER
General, United States Army
Chief of Staff

Official:

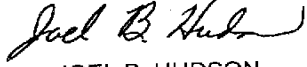

JOEL B. HUDSON
Administrative Assistant to the
Secretary of the Army

0335305

Distribution:

To be distributed in accordance with the initial distribution number 400322, with requirements for TM 9-1370-203-34.

CHANGE

NO. 2

HEADQUARTERS
DEPARTMENT OF THE ARMY
Washington, DC, 31 January 2002

TECHNICAL MANUAL
DIRECT SUPPORT AND GENERAL SUPPORT
MAINTENANCE MANUAL
FOR
MILITARY PYROTECHNICS

DISTRIBUTION STATEMENT A: Approved for public release; distribution is unlimited.

TM 9-1370-203-34, dated 05 March 1996 is changed as follows:

1. File this change sheet in front of the publication for reference purposes.
2. Remove old pages and insert new pages as indicated below.
3. New or changed material is indicated by a vertical bar in the outer margin of the page.
4. Added or revised illustrations are indicated by a vertical bar adjacent to the illustration identification number.

Remove pages

A and B
B-5 and B-6
D-7 and D-8

Insert pages

A and B
B-5 and B-6
D-7 and D-8

File this change sheet in front of the publication for reference purposes.

By Order of the Secretary of the Army:

Official:

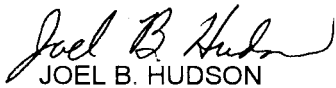

JOEL B. HUDSON
*Administrative Assistant to the
Secretary of the Army*

0202905

ERIC K. SHINSEKI
*General, United States Army
Chief of Staff*

Distribution:

To be distributed in accordance with the initial distribution number 400322, with requirements for TM 9-1370-203-34.

CHANGE

NO. 1

HEADQUARTERS
DEPARTMENT OF THE ARMY
Washington, DC, 14 February 2000

TECHNICAL MANUAL
DIRECT SUPPORT AND GENERAL SUPPORT
MAINTENANCE MANUAL
FOR
MILITARY PYROTECHNICS

DISTRIBUTION STATEMENT A: Approved for public release; distribution is unlimited.

TM 9-1370-203-34, dated 05 March 1996 is changed as follows:

1. Remove old pages and insert new pages as indicated below.
2. New or changed material is indicated by a vertical bar in the margin of the page.
3. Added or revised illustrations are indicated by a vertical bar adjacent to the illustration identification number.

Remove pages	Insert pages
A and B	A and B
i and ii	i and ii
B-5 thru B-8	B-5 and B-8
D-7 and D-8	D-7 and D-8

File this change sheet in front of the publication for reference purposes.

By Order of the Secretary of the Army:

Official:

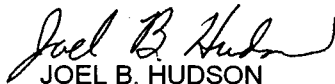

JOEL B. HUDSON

*Administrative Assistant to the
Secretary of the Army*

0004609

ERIC K. SHINSEKI
*General, United States Army
Chief of Staff*

Distribution:

To be distributed in accordance with the initial distribution number 400322, with requirements for TM 9-1370-203-34.

LIST OF EFFECTIVE PAGES

INSERT LATEST CHANGED PAGES. DESTROY SUPERSEDED PAGES.

NOTE The portion of the text affected by the changes is indicated by a vertical line in the outer margins of the page. Changes to illustrations are indicated by a vertical line adjacent to the identification number.

Dates of issue for original and changed pages are:

Original 0 5 March 1996	Change 3 30 January 2004
Change 1 14 February 2000	Change 4 14 September 2006
Change 2 31 January 2002	Change 5 DD Month YYYY

TOTAL NUMBER OF PAGES IN THIS PUBLICATION IS 65, CONSISTING OF THE FOLLOWING:

Page No.	*Change No.	Page No.	*Change No.	Page No.	*Change No.
Front Cover	0				
A	5				
B	0				
i thru iii	3				
iv	0				
1-1 and 1-2	4				
2-1 and 2-2	0				
3-1 thru 3-5	0				
3-6	3				
4-1 thru 4-12	0				
4-13	5				
4-14 thru 4-17	3				
4-18	5				
4-19 thru 4-20	3				
A-1 thru A-4	4				
B-1	0				
B-2 thru B-4	3				
B-5 and B-6	4				
B-7 and B-8	3				
C-1 thru C-6	0				
D-1 and D-2	0				
D-3	3				
D-4 thru D-6	0				
D-7	4				
D-8	5				
D-9 and D-10	0				

*Zero in this column indicates an original page

THIS PAGE INTENTIONALLY LEFT BLANK

Technical Manual)
)
No. 9-1370-203-34)

HEADQUARTERS
DEPARTMENT OF THE ARMY
Washington, DC, 5 March 1996

MAINTENANCE MANUAL for MILITARY PYROTECHNICS

REPORTING ERRORS AND RECOMMENDING IMPROVEMENTS

You can help improve this manual. If you find any mistakes or if you know of a way to improve the procedures, please let us know. You may mail, e-mail, or FAX your response. Mail your letter, DA Form 2028 (Recommended Changes to Publications and Blank Forms) located in the back of this manual direct to: Logistics Research and Engineering Directorate (AMSRD-AAR-AIL-LS), U.S. Army RDECOM, Armament Research, Development and Engineering Center, Picatinny, NJ 07806-5000. E-mail address is LSB@PICA.ARMY.MIL. FAX number is Commercial (973) 724-4633, DSN 880-4633. A reply will be furnished to you.

	Page
CHAPTER 1. INTRODUCTION	1-1
Section I. General	1-1
1.1 Scope.....	1-1
1.2 Forms, Records, and Reports.....	1-1
1.3 Destruction of Military Pyrotechnics to Prevent Enemy Use.....	1-2
Section II. Equipment Description and Data.....	1-2
1.4 General	1-2
Section III. Safety, Care, and Handling	1-2
1.5 General	1-2
CHAPTER 2. TOOLS AND EQUIPMENT	2-1
2.1 General	2-1
2.2 Tools and Equipment.....	2-1
2.3 Expendable and Durable Items List.....	2-1

*This manual supersedes TM 9-1370-203-34&P, dated 21 January 1976, including all changes.

CHAPTER 3.	INSPECTION REQUIREMENTS.....	3-1
Section I.	General.....	3-1
3.1	Purpose of Inspection.....	3-1
3.2	Ammunition Surveillance	3-1
3.3	Inspections.....	3-1
3.4	Inspection Methods.....	3-2
3.5	Extent of Inspections	3-2
Section II.	Classification of Material Defects	
3.6	General	3-2
3.7	In-Process and Final Inspection	3-3
3.8	Disposition of Lots After Maintenance	3-3
CHAPTER 4.	MAINTENANCE PROCEDURES	4-1
Section I.	Introduction.....	4-1
4.1	General	4-1
4.2	Direct Support Maintenance	4-1
4.3	General Support Maintenance.....	4-2
4.4	Unpacking and Repacking.....	4-2
4.5	Inspection	4-2
Section II.	Cleaning	4-2
4.6	Rust, Dirt, Grease, and Defective Marking Removal.....	4-2
Section III.	Touch-up, Painting, and Marking.....	4-4
4.7	Touching-up Containers	4-4
4.8	Repainting Containers	4-5
4.9	Remarking Barrier Bags, Containers, and Boxes.....	4-6
4.10	Wood Packing Box	4-15
4.11	Painting and Remarking of Light Boxes.....	4-15
Section IV.	Repair	4-16
4.12	Inspecting and Reconditioning Packing Box.....	4-16
4.13	Repalletization	4-16
APPENDIX A.	REFERENCES	A-1
APPENDIX B.	PACKING MATERIALS, ACCESSORIES, AND TOOLS	B-1
APPENDIX C.	EXPENDABLES AND DURABLE ITEMS LIST	C-1
APPENDIX D.	PACKING, MARKING, AND STORAGE DATA.....	D-1

LIST OF ILLUSTRATIONS

Figure	Title	Page
4-1.	Marking for MK 45 MOD 0 Parachute Aircraft Flare	4-7
4-2.	Marking for M206 Aircraft Countermeasure Flare Container	4-7
4-3.	Marking for MK 45 MOD 0 Parachute Aircraft Flare with Adapter Container	4-8
4-4.	Marking for Ground Signal Metal Container Except Container for M131 Signal	4-8
4-5.	Marking for Parachute Distress Red Star Ground Illumination M131 Signal Metal Container	4-9
4-6.	Marking for AN-M75 Signal Metal Container	4-9
4-7.	Marking for M110 Artillery Flash Simulator and Ground Signal Fiber Containers	4-10
4-8.	Marking for M142 Atomic Explosion Simulator Container	4-11
4-9.	Marking for Barrier Bag (Inner Pack)	4-12
4-10.	Example of Marking on Wooden Packing Box	4-12
4-11.	Marking for M2 Fire Starter Wooden Packing Box	4-13
4-11a.	Marking for M27 Foam Support Box	4-13
4-12.	Typical Palletization	4-18
4-13.	Marking for Box, Pallet type, Wirebound for M27	4-18
4-14.	Marking for M211 Aircraft Countermeasure Flare Container	4-19
4-15.	Marking for M212 Aircraft Countermeasure Flare Container	4-19

LIST OF TABLES

Number	Title	Page
3-1.	Classification of Packing Defects	3-3
4-1.	Colors for Painting and Marking Barrier Bags, Containers, and Boxes	4-5

THIS PAGE IS INTENTIONALLY LEFT BLANK

CHAPTER 1 INTRODUCTION

SECTION I GENERAL

1.1 SCOPE.

1.1.1 This is one of a series of technical manuals on maintenance of pyrotechnic materials. Information in this manual is limited to the responsibilities of Direct and General Support maintenance personnel.

1.1.2 Operator and Unit level maintenance instructions are covered in:

TM 9-1370-203-20 for Military Pyrotechnics;

TM 9-1370-201-12 for MK 45 Mod 0 Parachute Aircraft Flare;

TM 9-1095-206-12&P for M206 and M212 Aircraft Countermeasure Flares and M211 Infrared Countermeasure Decoy.

NOTE

The publications above also contain the pertinent Maintenance Allocation Chart (MAC). Authorized procedures for each level of maintenance, including Direct and General Support, are specified in the MAC.

1.1.3 Operating instructions are contained in:

TM 9-1370-206-10, Pyrotechnic Signals;

TM 9-1370-207-10, Pyrotechnic Simulators;

TM 9-1370-208-10, Photoflash Cartridges, Surfaces Flares and Miscellaneous Pyrotechnics.

1.2 FORMS, RECORDS, AND REPORTS.

1.2.1 Forms generally applicable to units maintaining this material are listed in appendix A. A current listing of all forms is maintained in DA PAM 25-30. DA PAM 750-8 contains instructions on applicability and completion of forms.

1.2.2 A record should be kept on an Army Depot Surveillance Record (DA Form 3022-R) in accordance with instructions in SB 742-1 of each inspection job undertaken. Unsatisfactory or unusual inspection results will be reported on an Ammunition Condition Report (DA Form 2415) in accordance with instructions in DA PAM 750-8.

1.3 DESTRUCTION OF MILITARY PYROTECHNICS TO PREVENT ENEMY USE.

Destruction of military pyrotechnics, when subject to capture or abandonment, will be undertaken by the user only when, in the judgement of the unit commander concerned, such action is necessary in accordance with orders or policy established by the Army Commander.

SECTION II DESCRIPTION AND DATA

1.4 GENERAL.

For a detailed description and data of military pyrotechnic items, refer to TM 43-0001-37 (Army Ammunition Data Sheets for Military Pyrotechnics).

SECTION III SAFETY, CARE, AND HANDLING

1.5 GENERAL.

Requirements for safety, care, and handling of pyrotechnic items and accessories are included in AR 385-64, DA PAM 385-64, and the pertinent operator and unit publications.

CHAPTER 2 TOOLS AND EQUIPMENT

2.1 GENERAL

Tools, equipment, and packing materials, in addition to those available to the using organization, are supplied to Direct and General Support maintenance units for maintaining military pyrotechnics.

2.2 TOOLS AND EQUIPMENT.

2.2.1 Tools, and accessories having general application to this materiel are authorized for issue by Packing Materials, Accessories, and Tools List (app B).

2.2.2 Except when otherwise indicated, local fabrication of tools and equipment is not authorized.

2.2.3 Special tools, required to accomplish the maintenance indicated in chapter 4, are listed in SC 494095-CL-A11 for Direct Support and SC 4935-95-CL-A03 for General Support.

2.3 EXPENDABLE AND DURABLE ITEMS LIST.

Appendix C lists expendable and durable items which are required by Direct Support and General Support maintenance personnel.

THIS PAGE INTENTIONALLY LEFT BLANK

CHAPTER 3 INSPECTION REQUIREMENTS

SECTION I. GENERAL

3.1 PURPOSE OF INSPECTION.

A complete plan of all maintenance work including inspections is required. Prepare Standing Operating Procedures (SOP) that contain detailed production techniques, standards, and controls necessary to produce a quality product. See the applicable sections of TM 9-1300-250 for planning procedures and SOP preparation and approval.

3.2 AMMUNITION SURVEILLANCE.

Surveillance includes those actions necessary to evaluate the current degree of serviceability of pyrotechnics. See AR 702-6, AR 740-1, AR 702-12, and SB 742-1 for policy, responsibilities and procedures applicable to the Ammunition Surveillance and Quality Evaluation Program.

3.3 INSPECTIONS.

3.3.1 Serviceability.

3.3.1.1 Pyrotechnic items will be inspected by a Quality Assurance Specialist (ammunition), or MOS 55X40 personnel under the guidance of a Quality Assurance Specialist (ammunition), to determine serviceability or unserviceability according to SB 742-1 and other pertinent SB's of the SB 742-1370 series (appendix A-4d).

3.3.1.2 Required maintenance for unserviceable materiel will be indicated on the inspection report (para 1-2b). Direct Support and General Support units are limited to maintenance on packaging materials for pyrotechnic items. Because of their uniqueness, work on the pyrotechnic items themselves is strictly a Depot level operation.

3.3.2 Pre-Maintenance. At the unpack operation prior to start of work, pyrotechnic external packaging materials will be screened one hundred percent. Direct Support and/or General Support will perform pre-maintenance screening which will include the following:

3.3.2.1 All packaging material items with defects, as listed in table 3-1, will be repaired or replaced during maintenance, if possible. Where the critical defect of conflicting or confusing markings cannot be positively resolved, and the packaging remarked to correct the problem, small quantities of the items may be disposed of locally. Where large quantities are involved, disposition instructions contained in para 3-8b will be followed.

3.3.2.2 Other evidence of poor workmanship or defects that could cause accelerated deterioration or adversely affect the protection of the items will be corrected.

3.3.3 In-Process.

3.3.3.1 In-process inspections are an integral part of the maintenance procedures to assure that previous

work is adequate and acceptable prior to proceeding with further operations.

3.3.3.2 Since these inspections are part of the maintenance procedures contained in chapter 4, they will not be specifically covered in this chapter.

3.3.4 Final Acceptance.

3.3.4.1 Packaged pyrotechnic items will be inspected after maintenance has been completed. The final acceptance inspection will determine whether or not maintenance accomplished has returned unserviceable packaging to an acceptable condition.

3.3.4.2 Quality Assurance Specialist (Ammunition), or MOS 55X40 personnel under the guidance of a Quality Assurance Specialist, will perform and certify this inspection prior to returning materiel to its storage area.

3.4 INSPECTION METHODS.

3.4.1 Visual Inspection. Careful observation of item, noting listed defects and any other abnormalities.

3.4.2 Manual Inspection. Movement by hand of specified area of item to determine if listed defect(s) exists (e.g., incorrect loose part).

3.4.3 Gage Inspection. Checking an item with a measuring instrument or a standard mating piece to determine if its size is acceptable in certain critical areas. Defects are derived from either predetermined standards or on a "go" "no go" basis (e.g., a ring gage).

3.5 EXENT OF INSPECT.

3.5.1 Sealed Packages. During maintenance inspections and operations on pyrotechnic items, those packed in barrier bags or sealed cans should not be opened. Therefore, sealed packages will usually be subjected only to visual inspection. A sample item may be opened (and disposed of) to determine proper marking for the packaging, if necessary.

3.5.2 Processed Item's. All processed items will be subjected to in-process inspections and a final acceptance inspection.

SECTION II. CLASSIFICATION OF MATERIAL DEFECTS

3.6 GENERAL.

Pyrotechnics packaging defects, listed in table 3-1, provide the required method of inspection during maintenance for categories of defects. Categories of defects listed in the table are defined in SB 742-1. An Acceptable Quality Level (AQL) established for each defect is provided in table 3-1 for evaluation during final acceptance inspection. Details on the use of AQL's in the SB's and table 3-1 will not be covered in this manual since AQL's are to be used only by personnel already completely familiar with them.

3.7 IN-PROCESS AND FINAL INSPECTION.

All pyrotechnic packing materials processed will be subject to in-process and final inspection to assure acceptability. In-process and final inspections will be included as an integral part of all maintenance standing operating procedures.

3.8 DISPOSITION OF LOTS AFTER MAINTENANCE.

3.8.1 Each lot that meets the AQL in table 3-1 is acceptable for issue and use. Where the critical defect of conflicting or confusing markings cannot be positively resolved and the packaging remarked to correct the problem, small quantities of the items may be disposed of locally. Where large quantities are involved, disposition instructions contained in b below will be followed.

3.8.2. Lots found with any critical or major defects, or a rejectable number of minor defects, will be inspected 100 percent and reworked within the capability of the unit as specified in the Maintenance Allocation Chart (MAC). If the required maintenance is beyond the capability of the unit and its supporting elements, request disposition instructions through command channels from the Director, US Army Armament and Chemical Acquisition and Logistics Activity, ATTN: AMSTA-AC-MAS, Rock Island, Illinois 61299-7630, in accordance with DA PAM 738-750.

3.8.3 Any maintenance operation which results in a change to the information on the Lot Ammunition Data Card requires the addition of an alphabetic suffix to the lot number. Suffixes will be obtained through command channels from the US Army Industrial Operations Command, ATTN: AMSIO-SMI, Rock Island, Illinois 61299-6000.

Table 3-1. Classification of Packing Defects

Component	Category	Defect	Method of inspection	Reference	AQL
POLYSTYRENE CONTAINERS (Incl MK 45 Mod 0 and PA 142 Containers)					
Container	Minor	Cracks, dents, pieces missing in top and bottom halves.	Visual	TM 9-1370-201-12	0.65
Markings	Major	Markings incorrect, incomplete or illegible	Visual	para 4-7	0.40
Tape	Major	Tape pieces missing, loose, or torn	Visual/ Manual	TM 9-1370-201-12	0.40
Preformed Packing	Minor	Damaged, split not properly seated pinched	Visual	TM 9-1370-201-20 &P (PA 142)	0.65
PALLETS, WOODEN BOXES, AND CRATES					
Hardware	Minor	Inoperative or loose Nails, screws, and fasteners which can be replaced or properly sealed.	Visual/ Manual	para 4-8	0.65
	Minor		Visual	para 4-8	0.65
Ends	Major	Damage which requires disassembly of	Visual	para 4-8	0.40

Table 3-1. Classification of Packing Defects (Continued)

Component	Category	Defect	Method of inspection	Reference	AQL
Ends	Major	Damage which requires disassembly of box.	Visual	para 4-8	0.40
	Minor	Broken or missing cleats and handles.	Visual	para 4-8	0.65
PALLETS, WOODEN BOXES, AND CRATES (Continued)					
Wood	Major	Splits closer than 1 inch to edge of board or adjoining split or over 1/8-inch wide, or board broken or missing	Visual/ Manual	para 4-8	0.40
	Major	Warping which prevents insertion or removal of rounds and/or sealing of the box.	Visual Manual Visual	para 4-8 para 4-8	0.40 0.40
	Major	Excessive mildew and mold which cannot be removed and which render the markings illegible.			
	Major	Holes or loose knots which exceed 1-1/2 inches in largest diameter or 1/3 width of board.	Visual	para 4-8	0.40
	Major	Knots greater than 1/4 the width of the skid.	Visual	para 4-8	0.40
	Minor	Splits over 3 inches but no closer than 1 inch to edge of board or adjoining split; or 1/8-inch wide, which can be repaired by use of corrugated fasteners.	Visual	para 4-8	0.65
	Minor	Loose skids.	Visual	para 4-8	0.65
Strapping	Major	Missing, rusted, distorted, broken, or loose.	Visual	TM 9-1370-203-20	0.40
Wires	Major	Broken, rusted through, missing, or loose.	Visual	TM 9-1370-203-20	0.40
Marking	Critical	Conflicting or confusing marking so that positive identification of the item is in doubt. Applicable only to signals.	Visual	SB 742-1	Correct or demil
	Major	Incorrect, illegible or incomplete.	Visual	para 4-7	0.40
FIBER CONTAINERS					
Metal ends	Major	Perforations, excessive rust, or ends which are crushed or not securely crimped to body.	Visual	TM 9-1370-203-20	Demil

Table 3-1. Classification of Packing Defects (Continued)

Component	Category	Defect	Method of inspection	Reference	AQL
Body and cap	Major	Cuts, tears, or gouges more than 1/2 square inch in area, or through all impregnated layers.	Visual	TM 9-1370-203-20	Demil
	Major	Molded, mildewed; or rotted.	Visual	para 4-4	0.40
	Major	Wrinkled or peeling.	Visual	TM 9-1370-203-20	0.40
FIBER CONTAINERS (Continued)					
	Major	Blisters with combined area of more than 1/2 square inch.	Visual	TM 9-1370-203-20	0.40
	Major	Wet or soft containers	Visual/ Manual	TM 9-1370-203-20	0.40
	Minor	Cuts, tears, or gouges less than 112 square inch in area, but not through all impregnated layers.	Visual	TM 9-1370-203-20	0.65
Marking	Critical	Conflicting or confusing marking so that positive identification of the item is in doubt. Applicable only to signals.	Visual	SB 742-1	Correct or demil
	Major	Incorrect, illegible, or incomplete.	Visual	para 4-7	0.40
METAL CONTAINERS (Including steel drum M142 Atomic Explosion Simulator)					
Body	Major	Dents which impair the structural integrity of the material.	Visual	TM 9-1370-203-20	0.40
	Major	Loose or leaking seams.	Visual	TM 9-1370-203-20	Demil
	Major	Rust which has caused excessive pitting.	Visual	TM 9-1370-203-20	Demil
	Major	Perforated.	Visual	TM 9-1370-203-20	Demil
	Minor	Minor rust which can be removed.	Visual	Para 4-4a	0.65
Caps and covers	Major	Rust which has caused excessive pitting.	Visual	TM 9-1370-203-20	Demil
	Major	Perforated.	Visual	TM 9-1370-203-20	Demil
	Major	Head of drum cocked or otherwise inadequately fastened.	Visual/ Manual	TM 9-1370-203-20	0.40
	Minor	Minor rust which can be removed.	Visual	para 4-4a	0.65

Table 3-1. Classification of Packing Defects (Continued)(Continued)

Component	Category	Defect	Method of inspection	Reference	AQL
Body and cap	Minor	Protective coating with a bare spot in excess of 1/4 square inch or an aggregate of bare spots whose total area exceeds 1/4 square inch.	Visual	TM 9-1370-203-20	0.65
Marking	Critical	Conflicting or confusing marking so that positive identification of the item is in doubt. Applicable only to signals.	Visual	SB 742-1	Correct or demil
	Major	Incorrect, illegible, or incomplete.	Visual	para 4-7	0.40
BARRIER BAGS					
Barrier material	Major	Tears, cuts, perforations, sealing open.	Visual	TM 9-1370-203-20	Demil
Marking	Critical	Conflicting or confusing marking so that positive identification of the item is in doubt. Applicable only to signals.	Visual	SB 742-1	Correct or demil
	Major	Incorrect and/or illegible	Visual	para 4-7	0.40
FOAM SUPPORT BOX					
Body	Major	Signs of deterioration.	Visual	TM 9-1370-203-20	Demil
	Major	Dents exist in foam.	Visual	TM 9-1370-203-20	Demil
	Major	Holes or cracks exist in foam.	Visual	TM 9-1370-203-20	Demil

CHAPTER 4 MAINTENANCE PROCEDURES

SECTION I. INTRODUCTION

4.1 GENERAL.

4.1.1 Direct Support (DS) and General Support (GS) maintenance operations are restricted to the procedures in this manual and the procedures specified in the (MAC) charts of the publications referenced in paragraph I.b. On pyrotechnic materials Direct Support and General Support units are limited to maintenance on packaging materials.

4.1.2 Repair parts, packing materials, and expendable supplies (appendixes B and C) required by Direct Support and General Support units will be locally stocked. Direct Support and General Support units are also responsible for receiving and storing packaging materials salvaged from expended ammunition and for providing technical assistance to Operator and Organizational units.

4.1.3 Before beginning maintenance operations, a line layout and Standing Operating Procedures (SOP) are required. Guidelines for organizing the line and writing the SOP are contained in TM 9-1300-250.

4.1.4 In general, maintenance operations include but are not limited to the following:

4.1.4.1 Cleaning and preservation of packaging materials.

4.1.4.2 Removal of light rust and corrosion from metal packaging.

4.1.4.3 Repair and replacement of packaging materials.

4.1.4.4 Painting and markings.

4.1.5 Expendable supplies are listed in appendix C.

4.2 DIRECT SUPPORT MAINTENANCE.

4.2.1 Direct Support maintenance is performed under the following conditions.

4.2.1.1 Upon receipt of unserviceable ammunition.

4.2.1.2 When maintenance is authorized to correct deficiencies in suspended ammunition lots.

4.2.1.3 When Operator and/or Organizational units request on-site assistance.

4.2.1.4 When inspection of on-hand stocks reveals the need.

4.2.2 Refer to FM 9-19 for mission and organization.

4.3 GENERAL SUPPORT MAINTENANCE.

General Support maintenance is accomplished under the same conditions as Direct Support maintenance but on greater quantities of ammunition. Refer to FM 9-19 for mission and organization.

4.4 UNPACKING AND REPACKING.

Step by step unpacking and repackaging procedures are given in TM 9-1370-203-20&P and TM 9-1370-201-12.

4.5 INSPECTION.

Premaintenance, in-process, and final inspection requirements are defined in chapter 3.

SECTION II. CLEANING

4.6 RUST, DIRT, GREASE, AND DEFECTIVE MARKING REMOVAL.

CAUTION

Dispose of rags contaminated with solvents by submerging in water in approved waste can to await burning

4.6.1 Metal Containers and Metal Ends of Fiber Containers.

a. Include the following materials, tools and equipment:

- (1) Abrasive material - sandpaper or corrosion removing compound.
- (2) Disposable gloves.
- (3) Can for flammable waste.
- (4) Non-sparking wire brush.
- (5) Plunger - type safety can.
- (6) Rags.
- (7) Alcohol.
- (8) Work bench.
- (9) Personal safety equipment (safety glasses).

- b. Receive material from unpacking or inspection operation
- c. Remove dirt, mud, and other foreign material, using rags or brushes. Use rags dampened with alcohol to remove grease.
- d. Using wire brush, remove flaked, chipped, blistered, or peeling paint.
- e. Remove rust, using wire brush, sandpaper, or corrosion removing compound.
- f. Inspect container for cracks or other damage or deterioration.
- g. Allow alcohol-cleaned surfaces to dry thoroughly before painting.

4.6.2 Non-metallic Surfaces (BBarrier Bag. Body of Fiber Container. Container for Mk45 Mod 0 Parachute Aircraft Flares).

- a. Include the following materials, tools and equipment:
 - (1) Alcohol.
 - (2) Disposable gloves.
 - (3) Rags.
 - (4) Work bench.
 - (5) Personal safety equipment (safety glasses).
- b. Receive material from unpacking or inspection operation.
- c. Remove dirt, mud, and other foreign material, using rags or brushes.
- d. Use alcohol sparingly if necessary to complete cleaning. Dampen clean rag with alcohol and wipe surface. Do not use detergent and water.
- e. Wipe surface thoroughly with clean dry rag to remove all grit, paint chips, residual alcohol, etc.
- f. Inspect container for cracks or other damage or deterioration.
- g. Allow alcohol-cleaned surfaces to dry thoroughly before painting.

SECTION III. TOUCH-UP, PAINTING, AND MARKING**4.7 TOUCHING-UP CONTAINERS.**

- a. Include the following materials, tools, and equipment:
 - (1) Disposable gloves.
 - (2) Enamel - applicable color as indicated in table 4-1.
 - (3) Zinc chromate primer (used only when painting bare metal).
 - (4) Masking tape.
 - (5) Flammable waste can.
 - (6) Paint brush.
 - (7) Rags.
 - (8) Work bench.
- b. Receive material from cleaning operation.
- c. Cover those markings and areas which are in good condition with masking tape.
- d. Apply thin coat of primer over any bare metal and allow to dry. Brush or spray can may be used.
- e. Apply two very thin coats of enamel. Allow first coat to dry thoroughly before applying second coat. Brush or spray can may be used.
- f. Place material in safe location in work area until paint has dried.
- g. Remove masking tape.
- h. Restore marking, if required (para 4-9).

CAUTION

Wear respirator during paint spraying operation.

Table 4-1. Colors for Painting and Marking Barrier Bags, Containers, and Boxes

Item Body Marking End

Item	Body	Marking	End
SIGNAL, ILLUMINATION, GROUND: (Metal Container) Green Star, Cluster, M125A1 Red Star, Cluster, M158 White Star, Cluster, M159 Red Star, Parachute, M126A1 White Star, Parachute, M127A1 Green Star, Parachute, M195 Red Star, Distress, Parachute, M131	Gray Gray Gray Gray Gray Gray Gray	Black Black Black Black Black Black Black	Green Red White Red White Green Gray
SIGNAL, SMOKE, GROUND: (Metal Container) Green Parachute, M128A1 Red, Parachute, M129A1	Gray Gray	Black Black	Green Red
SIGNALS, SMOKE, GROUND: M62, (Fiber Container) M64, M65 and M66	None	White	Black
FLARES, AIRCRAFT: (Plastic Container) Parachute, Mk 45 Mod 0 and Mk 45 w/Adapter	None	Black	None
SIMULATOR, ATOMIC EXPLOSION: (Steel Drum) M142	White w/ brown stripe	Black	White
INNER PACK, Barrier Material (Refer to Appendix D for applicable item)	None	Black	None
BOXES, WOOD	None	Black	None

4.8 REPAINTING CONTAINERS.

a. Include the following materials, tools and equipment:

- (1) Disposable gloves.
- (2) Enamel.
- (3) Flammable liquid safety can.
- (4) Paint brush or paint spray outfit.
- (5) Masking tape.
- (6) Rags.
- (7) Respirator.

- (7) Respirator..
- (8) Solvent.

b. Receive materiel from cleaning operation.

WARNING

Wear respirator during paint spray operation.

- c. Cover undamaged existing markings, if applicable, with masking tape.
- d. If possible, suspend container so it may all be painted at once. Otherwise, paint container in two stages, allowing first-painted areas to dry before turning container over to paint the rest.
- e. Using spray can or brush, cover bare metal with primer and allow to dry.
- f. Using sprayer, spray can or brush, paint container with two coats allowing first coat to dry before applying second.
- g. Inspect to assure paint coverage. Touch up as necessary.
- h. Remove masking tape, where applied.
- i. Touch up or replace markings as required following procedures in paragraph 4-9.

4.9 REMARKING BARRIER BAGS, CONTAINERS, AND BOXES.

4.9.1 General.

a. Materials, tools and equipment include the following:

- (1) Disposable gloves.
- (2) Marking stencil ink.
- (3) Plunger-type safety can.
- (4) Rags.
- (5) Rubber marking outfit or stencil and stencil brush.
- (6) Solvent.
- (7) Work table

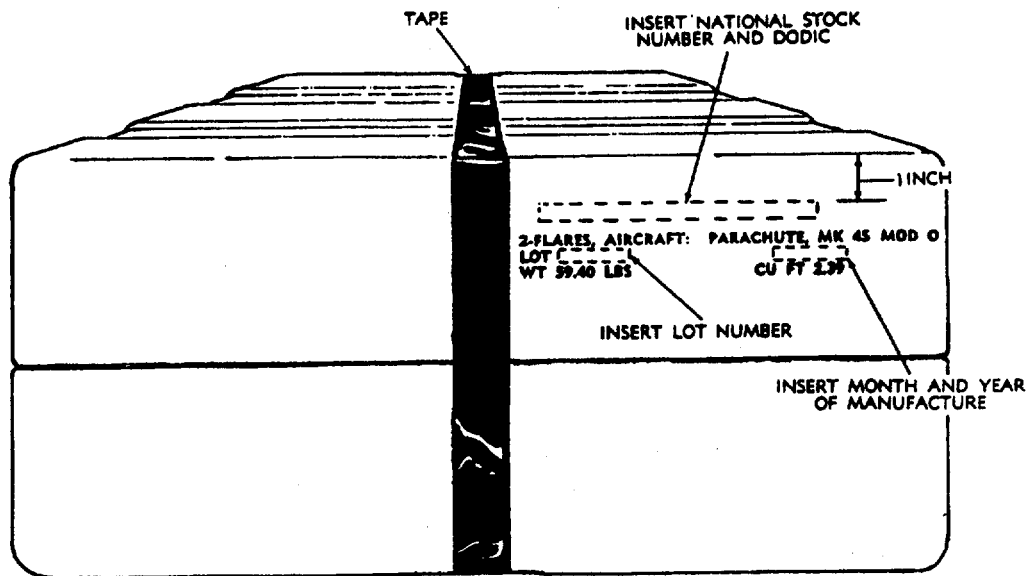

NOTE: HEIGHT OF LETTERS - 1/4"
SPACE BETWEEN LINES - 1/8"
LOCATE MARKINGS ON BOTH ENDS
OF CONTAINER

AR 100001-A

Figure 4-1. Marking for Mk 45 MOD O Parachute Aircraft Flare Container.

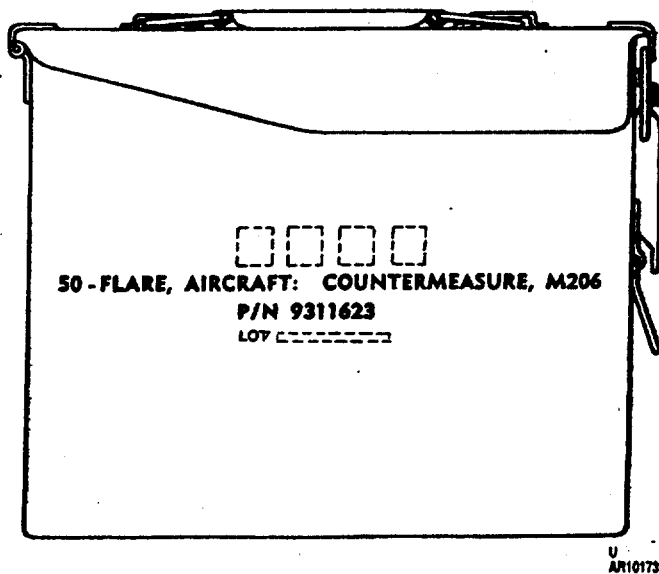

U
AR101736

Figure 4-2. Marking for M206 Aircraft Countermeasure Flare Container.

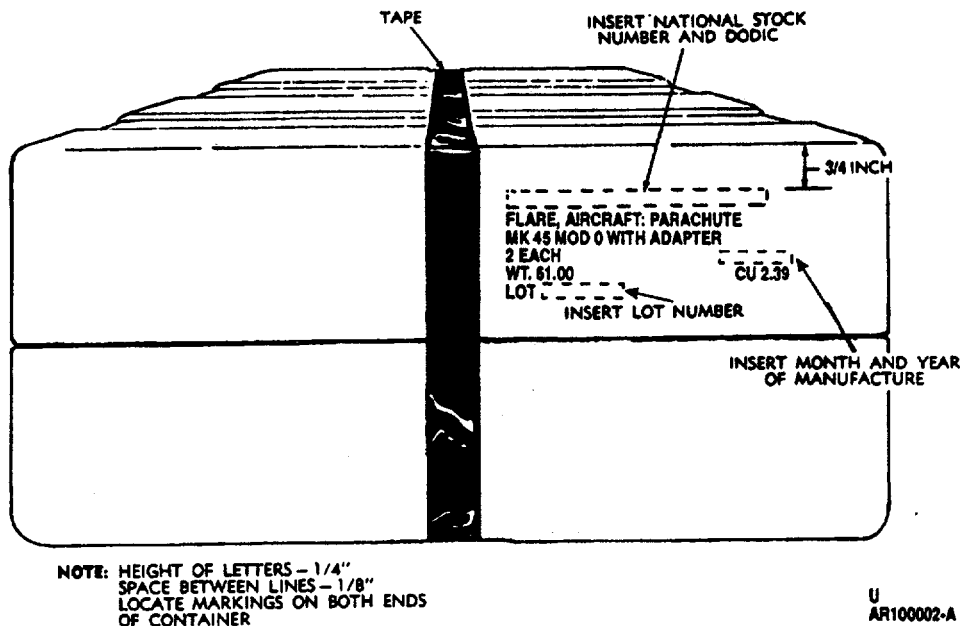

Figure 4-3. Marking for Mk 45 MOD 0 Parachute Aircraft Flare with Adapter Container.

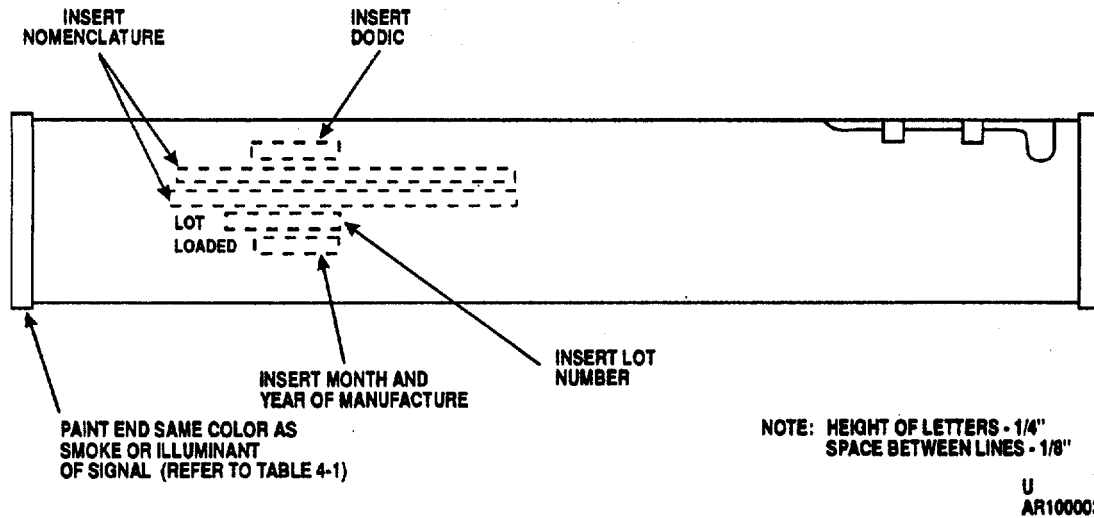

Figure 4-4. Marking for Ground Signal Metal Container Except Container for M131 Signal.

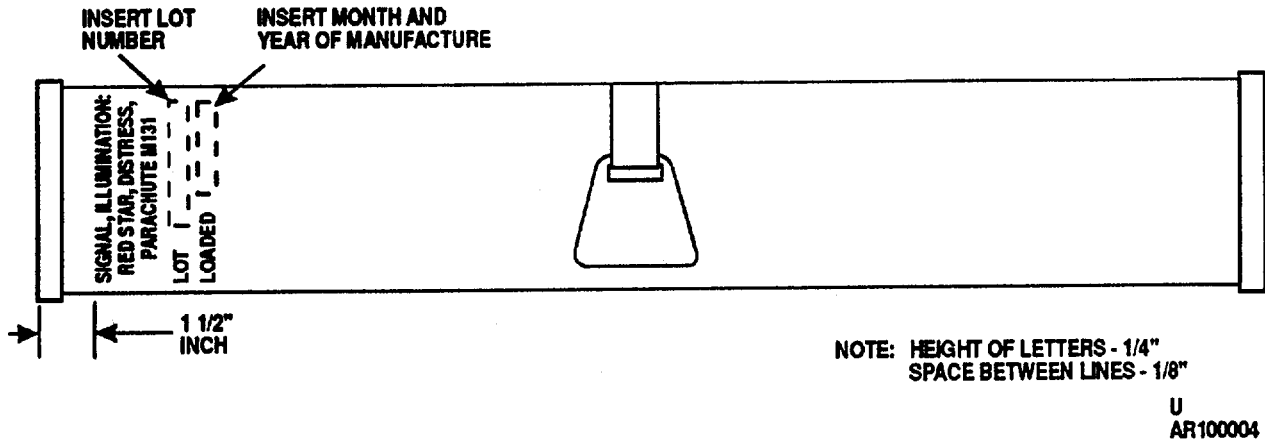

Figure 4-5. Marking for Parachute Distress Red Star Ground Illumination M13 Signal Metal Container.

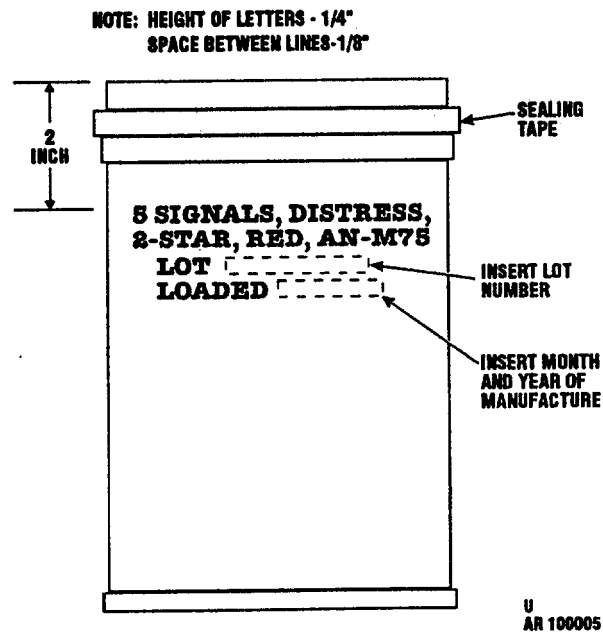
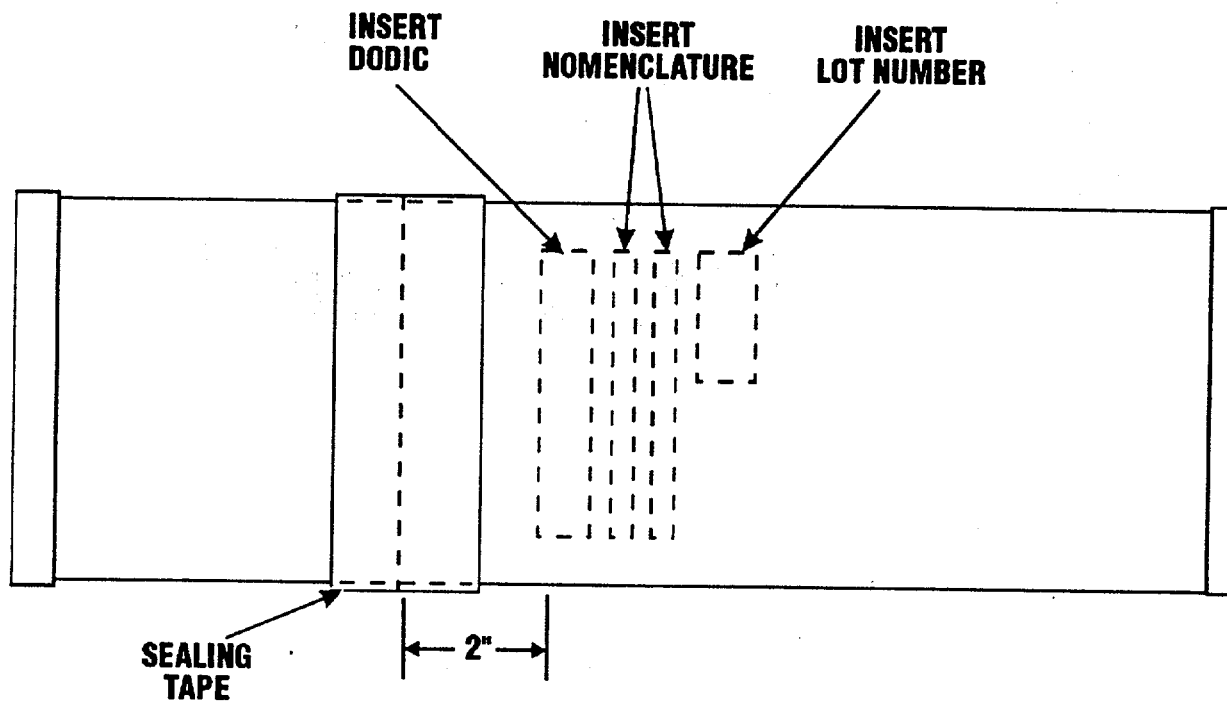

Figure 4-6. Marking for AN-M75 Signal Metal Container.



NOTE: HEIGHT OF LETTERS:
DODIC AND LOT NUMBER-3/4"
NOMENCLATURE-1/4"
SPACE BETWEEN LINES-1/8"

U
AR 10006

Figure 4-7. Marking for MI10 Artillery Flash Simulator and Ground Signal Fiber Containers.

NOTE: ALL LETTERING - 3/4 INCH HIGH
LOCATE AS ILLUSTRATED

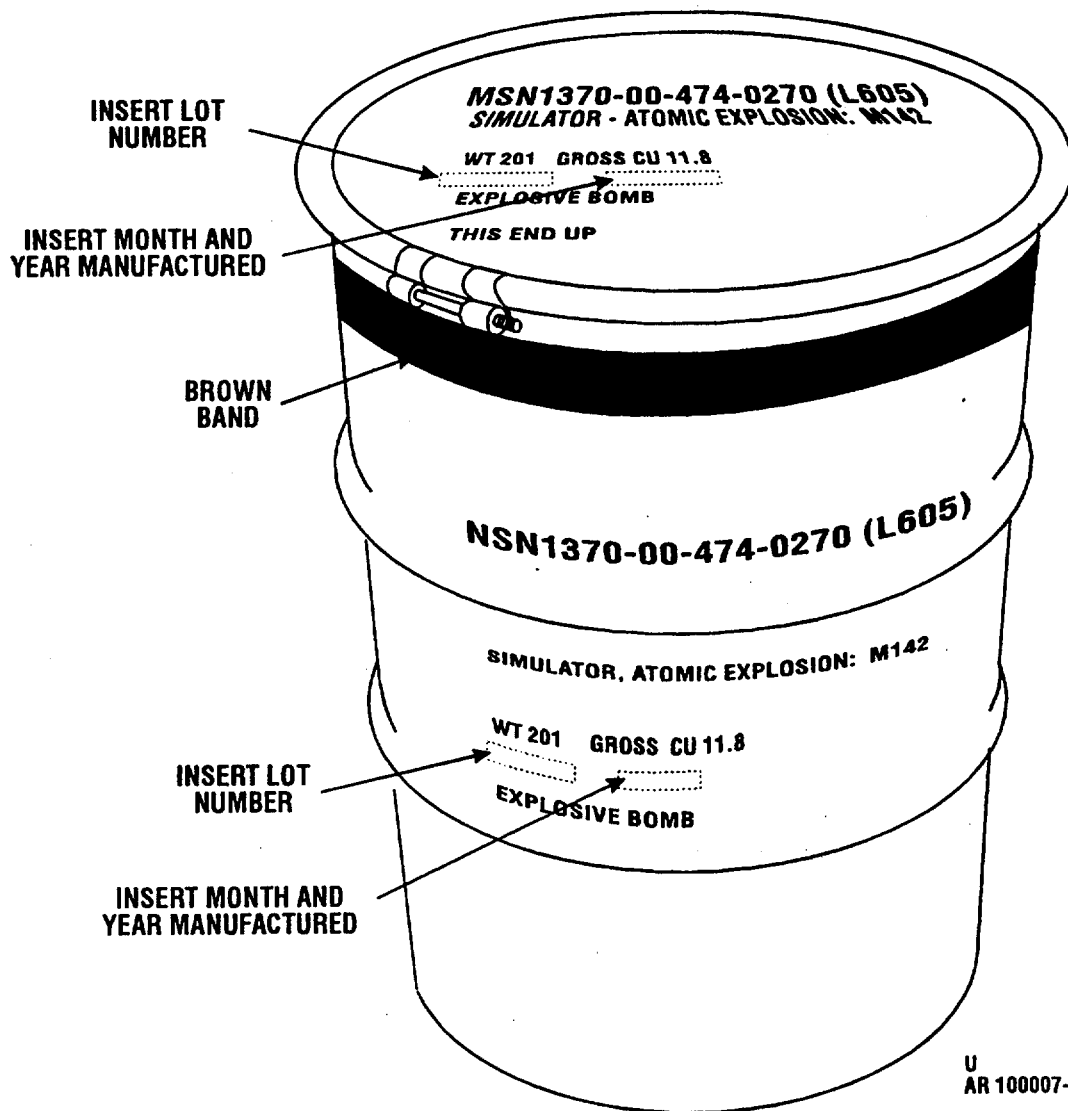
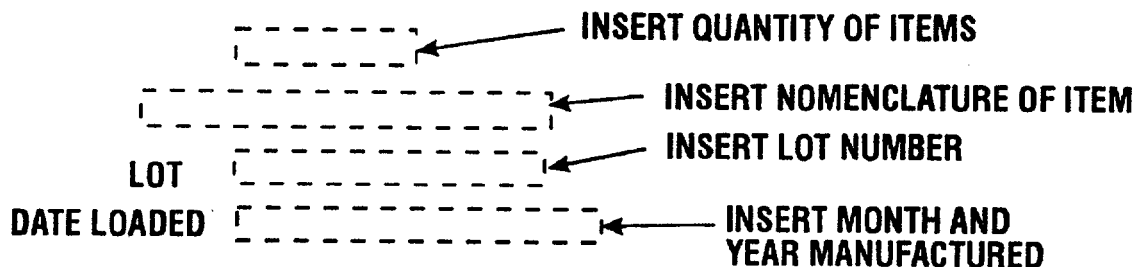

Figure 4-8. Marking for M142 Atomic Explosion Simulator Container.



NOTE:

HEIGHT OF LETTERS - 1/4"
 SPACE BETWEEN LINES - 1/8"
 LOCATE MARKING CENTRALLY ON
 SURFACES HAVING LARGEST AREA

u
 AR 100008

Figure 4-9. Marking for Barrier Bag (Inner Pack).

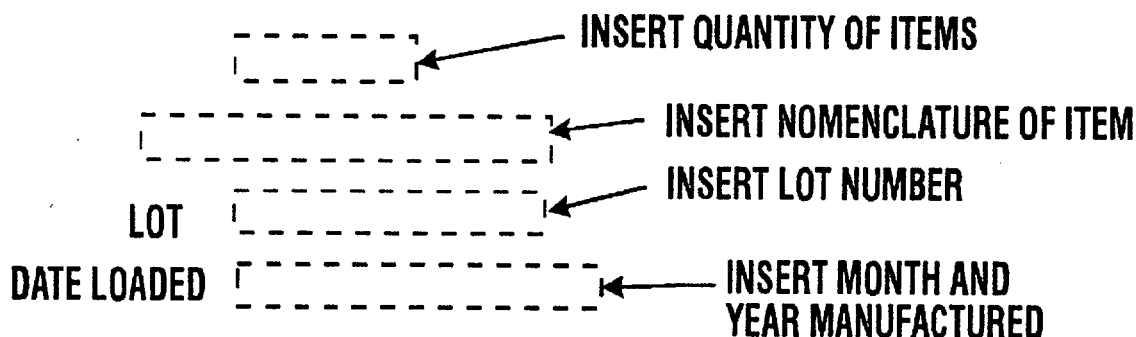

NOTE:

HEIGHT OF LETTERS - 1/4"
 SPACE BETWEEN LINES - 1/8"
 LOCATE MARKING CENTRALLY ON
 SURFACES HAVING LARGEST AREA

u
 AR 100008

Figure 4-10. Example of Marking on Wooden Packing Box.

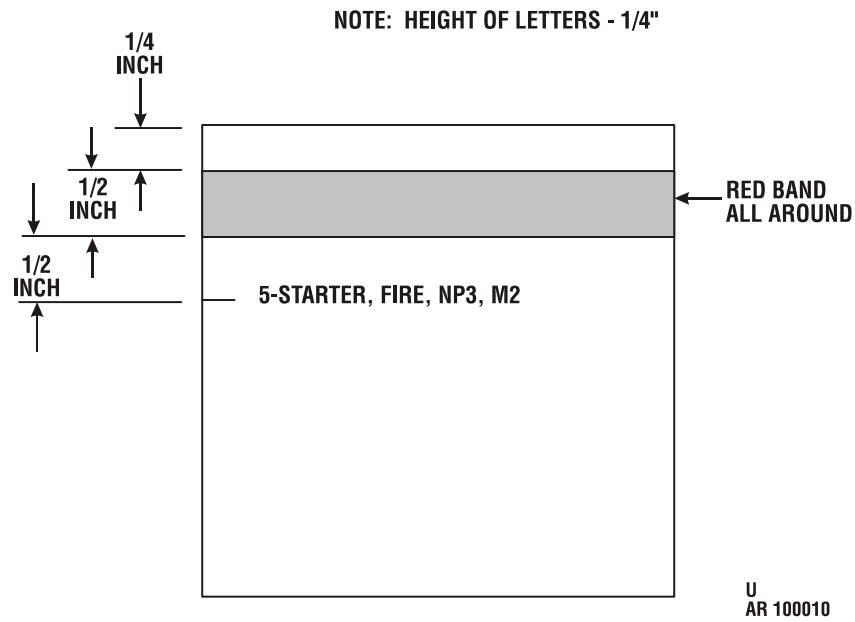

Figure 4-11. Marking for M2 Fire Starter Wooden Packing Box.

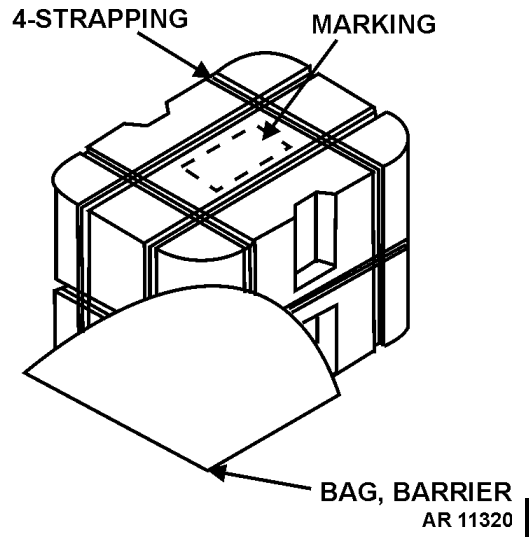

Figure 4-11a. Marking for M27 Foam Support Box.

- b. Refer to figures 4-1 through 4-11a for location, height of lettering and applicable data pertaining to markings.
- c. Refer to table 4-1 for required color of markings.

- d. If necessary, paint in the appropriate color may be substituted for ink when stenciling.
- e. Clean all marking equipment as often as necessary and at the end of each shift or termination of the job, whichever comes first.

4.9.2 Procedure.

- a. Receive materiel from inspection, cleaning, touch-up or painting operation.
- b. Mark by the more applicable or convenient method below:
 - (1) Rubber-type methods.
 - (a) Set type in holder giving required information.
 - (b) Put a dab of ink on ink plate.
 - (c) Roll brayer back and forth on ink plate to spread ink on brayer.
 - (d) Roll inked brayer lightly across face of rubber type to apply light film of ink to type.
 - (e) Place material with cylindrical surfaces in position to receive marking, then roll carefully across face of rubber type to apply ink marking.
 - (f) Place material with flat surfaces in position to receive marking, then bring rubber type into contact with material.
 - (2) Stencil methods.
 - (a) Make stencil for applicable marking.
 - (b) Put a dab of ink on plate.

NOTE

A spray gun or spray can with paint of appropriate color may be used as an alternate for ink.

- (c) Dip brush in ink to apply ink to bristles.
- (d) Position stencil over location on material to receive marking.
- (e) While holding stencil firmly against material (making tape may be used) rub bristles of brush over stencil to apply inked marking to material.
- (f) Remove stencil carefully.

(3) Allow ink to dry before handling material.

(4) Check markings to assure that they are correct, neat, and legible. Touch up as necessary.

4.10 WOOD PACKING BOX.

4.10-1 General.

Painting wooden boxes in order to obliterate old markings.

a. Tools and equipment include the following:

(1) Paint sprayer.

(2) Can, disposable flammable waste.

(3) Safety can, plunger type.

b. Expendable supplies include the following:

(1) Masking tape.

(2) Paint, ammunition.

(3) Lacquer, obliterating.

4.10.2 Procedure.

a. Assure that box is clean and dry.

b. Cover valid markings, if legible, with masking tape.

CAUTION

Wear Respirator During Spray Paint Operations.

c. Spray with olive-drab enamel or marking obliterating lacquer as required to obliterate unwanted markings.

d. Air-dry until surface is no longer tacky.

e. Inspect to assure complete coverage. Repaint spots if necessary.

f. Mark box using stencil method (4-9.2b(2) above).

4.11 PAINING AND REMARKING OF LIGHT BOXES.

Boxes with less than full contents will be painted and marked as specified in TM 9-1370-203-20.

SECTION IV. REPAIR

4.12 INSPECTING AND RECONDITIONING PACKING BOX.

- a. Materials, tools and equipment include the following:
 - (1) Claw hammer.
 - (2) Enamel.
 - (3) Hand nail puller.
 - (4) Marking ink.
 - (5) Nails (assorted sizes).
 - (6) Paint brush.
 - (7) Rags.
 - (8) Roller conveyor.
 - (9) Screwdriver.
 - (10) Stencil (to be made on site).
 - (11) Solvent.
 - (12) Work table.
- b. Receive packing box from unpacking.
- c. Examine box. Repair, recondition, accept or reject as prescribed in TM 9-1370-203-20.
- d. Transfer accepted packing box to packing operation. Mark and place rejected boxes in reject area pending disposal.

4.13 REPALLETIZATION.

- a. Materials, tools, and equipment include the following:
 - (1) Steel strapping, 1-1/4 in. wide, length as required.
 - (2) Seals for 1-1/4 in. steel strapping.
 - (3) Strapping and sealing kit, 1-1/4 in.
 - (4) Personal safety equipment as required by TM 9-1300-250, AR 385-64, and DA Pam 385-64 (goggles, gloves, shoes, etc.).

- b. Obtain good pallets from salvage.
- c. Place boxes on pallet. Refer to appendix D for arrangement.
- d. Install strapping, one strap per row of boxes as shown on figure 4-12 as follows:
 - (1) Cut pieces of strapping in lengths sufficient to completely encircle boxes and pallet with approximately 8 inches overlap.
 - (2) Position one strap under pallet.
 - (3) Insert one end of strap into strap stretch so that strap is held firmly by stretcher, with approximately 3 inches of strap protruding.
 - (4) Place seal over strap end.
 - (5) Thread loose end of strap through seal and into stretcher bead.
 - (6) Tighten strap by repeated movement of ratchet lever until edges begin to cut into boxes.
 - (7) Using banding crimper, crimp seal in two places.
 - (8) Release locking panel on stretcher and slide stretcher out.
 - (9) Cut off excess strapping.
 - (10) Repeat procedures outlined in (2) through (9) above for each strap.

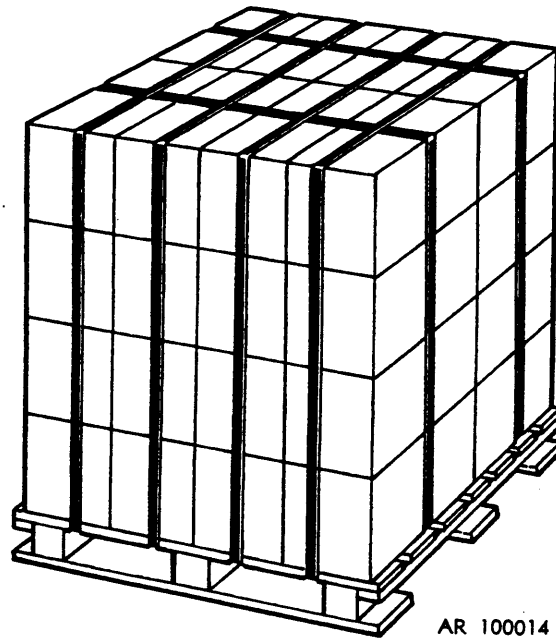

AR 100014

Figure 4-12. Typical Palletization.

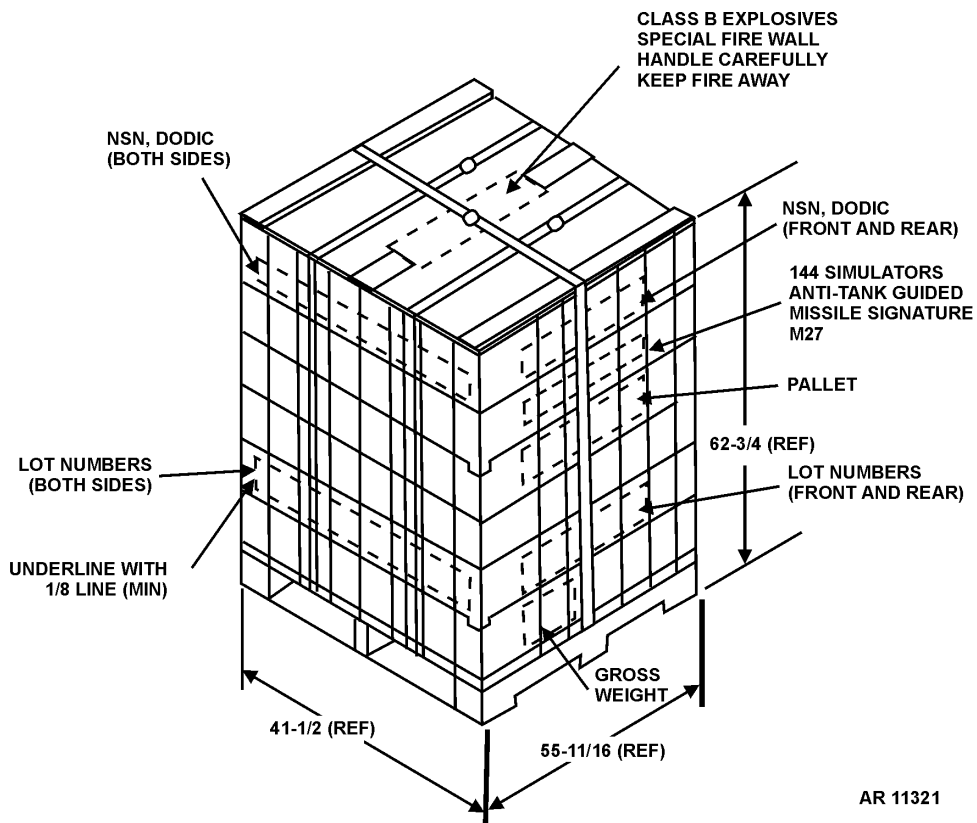

AR 11321

Figure 4-13. Marking for Box, Pallet Type, Wirebound for M27.

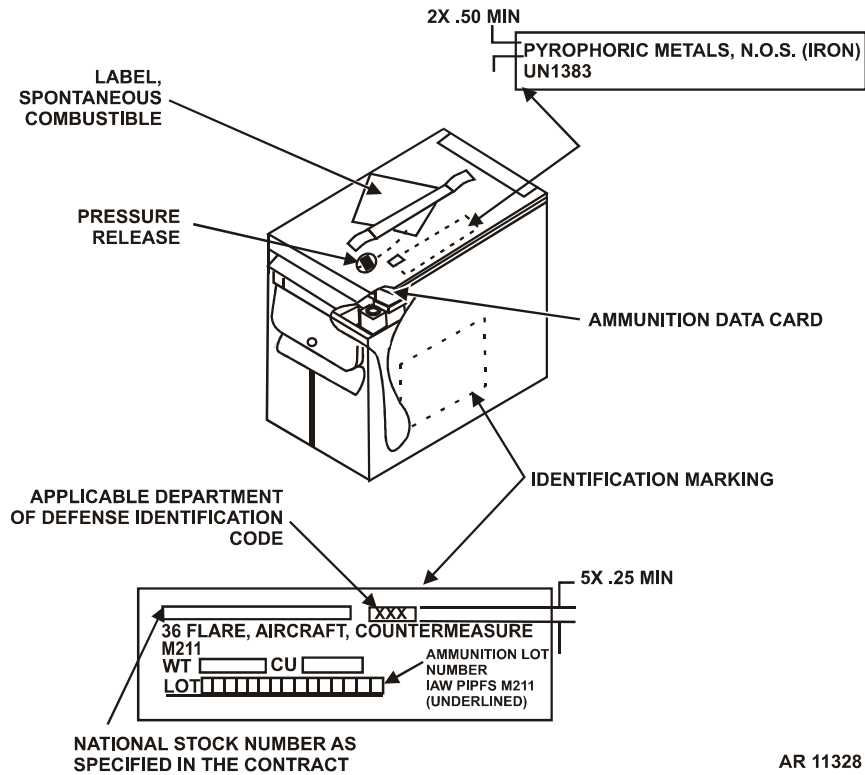

AR 11328

Figure 4-14. Marking for M211 Aircraft Countermeasure Flare Container.

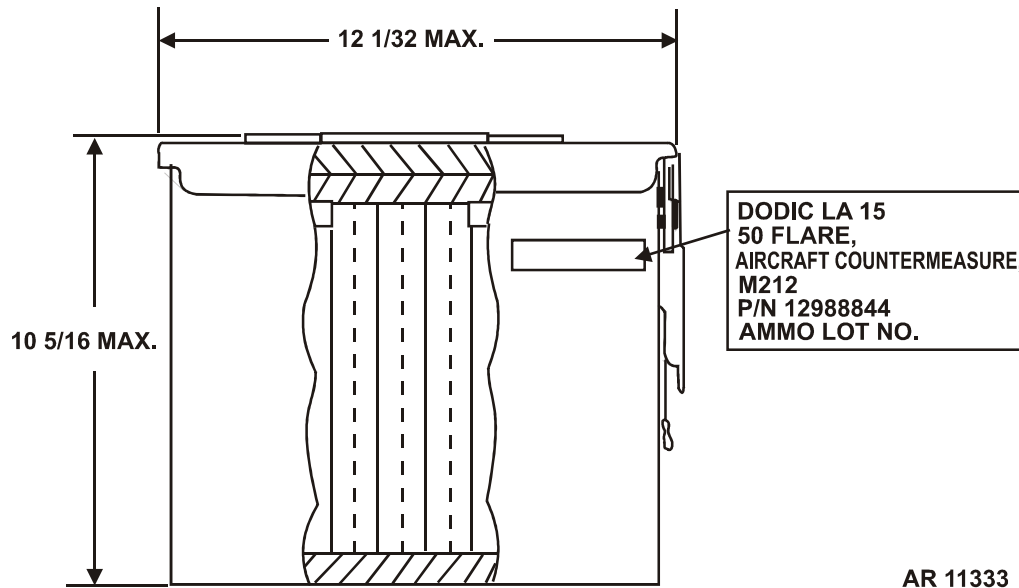

AR 11333

Figure 4-15. Marking for M212 Aircraft Countermeasure Flare Container.

THIS PAGE INTENTIONALLY LEFT BLANK

APPENDIX A REFERENCES

A.1 SCOPE.

This appendix lists all Army regulations, field manuals, forms, pamphlets, supply bulletins, supply catalogs, and technical manuals referenced in this manual. The publication index (DA Pam 25-30) should be consulted frequently for latest changes or revisions of references given in this appendix and for new publications relating to the material covered in this manual.

A.2 ARMY REGULATIONS.

U.S. Army Explosives Safety Program	AR 385-64
Quality Assurance Specialist (Ammunition Surveillance).....	AR 702-12
Army Stockpile Reliability Program (ASRP)	AR 702-6
Storage and Supply Activity Operations	AR 740-1

A.3 FIELD MANUALS.

Grenades and Pyrotechnic Signals	FM 3-23.30
--	------------

A.4 FORMS.

Recommended Changes to Publications and Blank Forms.....	DA Form 2028
Ammunition Condition Report.....	DA Form 2415
Army Depot Surveillance Record (LRA).....	DA Form 3022-R

A.5 PAMPHLETS.

Consolidated Index of Army Publications and Blank Forms.....	DA Pam 25-30
Ammunition and Explosives Safety Standards	DA Pam 385-64
The Army Maintenance Management System (TAMMS) Users Manual.....	DA Pam 750-8

A.6 SUPPLY BULLETINS .

Inspection of Supplies and Equipment Ammunition Surveillance Procedures.....	SB 742-1
Signal, Illumination, Ground: Green Star, Parachute, M19 Series; Surveillance Function Test	SB 742-1370-3
Simulator, Projectile, Air Burst, M27A1B1; surveillance Function Test.....	SB 742-1370-6
Simulator, Projectile, Air Burst; Charge, Smoke Puff, White; Surveillance Function Test	SB 742-1370-8
Flare, Surface: Trip, M49; Surveillance Function Test	SB 742-1370-9

A.6 SUPPLY BULLETINS - Continued.

Signal, Illumination, Aircraft: Double Star, Red-Red, AN-M37 Series; Double Star, Yellow-Yellow, AN-M38 Series; Double Star, Green-Green, AN-M39 Series; Double Star, Red-Yellow, AN-M40 Series; Double Star, Red-Green, AN-M41 Series; Double Star, Green-Yellow, AN-M42 Series; Surveillance Function Test	SB 742-1370-11
Signal, Illumination, Aircraft: Yellow Tracer, Red-Yellow Star, AN-M53 Series; Green Tracer, Red-Red Star, AN-M54 Series; Green Tracer, Green-Red Star, AN-M55 Series; Red Tracer, Green-Green Star, AN-M56 Series; Red Tracer, Red-Red Star, AN-M57 Series; Red Tracer, Green-Red Star, AN-M58 Series; Surveillance Function Test	SB 742-1370-12
Detonation, Simulator, Explosive: M80; Surveillance Function Test	SB 742-1370-13
Fusee, Warning Railroad: Red, 20 Minute, M72; Surveillance Function Test	SB 742-1370-14
Signal, Illumination, Ground: Star Cluster, White, M18 Series; Green, M20 Series; Amber, M22 Series; Red, M52 Series Surveillance Function Test	SB 742-1370-15
Signal, Smoke, Ground: Red, M62; Yellow, M64; Green M65 Surveillance Function Test	SB 742-1370-16
Signal, Illumination, Red Star, Distress, Parachute, M131 Surveillance Function Test	SB 742-1370-37
Simulator, Projectile Airburst, Liquid (SPAL): M9 Ammunition Surveillance Procedures	SB 742-1370-94-4
Simulator, Projectile, Ground Burst: M115 Series Ammunition Surveillance Procedure	SB 742-1370-94-418
Signal Kit, Personnel, Distress: M185 and Signal Kit, Personnel, Distress: M186 Ammunition Surveillance Procedures	SB 742-1370-94-455
Signal, Illumination Ground: Parachute, Red Star, M126 Series; White Star, M127 Series; Green Star, M195 Ammunition Surveillance Procedure	SB 742-1370-94-700
Signal, Illumination, Ground: Star Cluster, Green, M125 Series (1370-L314); Red, M158 (1370-L306); and White, M159 (1370-L307) Ammunition Surveillance Procedures	SB 742-1370-94-703
Signal, Illumination, Aircraft, Single Star: Red-AN-M43A1/A2 (1370-L231); Yellow-AN-M44A1/A2 (1370-L232); Green-AN-M45A1/A2 (1370-L233) Ammunition Surveillance Procedures	SB 742-1370-94-704
Signal, Smoke, Ground: Parachute, M128A1, Green (1370-L324); M129A1, Red (1370-L323); M194, Yellow (1370-L293) Ammunition Surveillance Procedures	SB 742-1370-94-720
Signal, Smoke and Illumination, Marine: AN-MK 13 Mod 0 (DODAC 1370-L275) Ammunition Surveillance Procedures	SB 742-1370-94-721
Simulator, Projectile, Air Burst: M74 Series Ammunition Surveillance Procedures (1370-L366)	SB 742-1370-94-740
Simulator, Booby Trap: Flash, M117; Simulator, Booby Trap: Illuminating, M118; and Simulator, Booby Trap: Whistling, M119 Ammunition Surveillance Procedures	SB 742-1370-94-741

A.6 SUPPLY BULLETINS - Continued.

Simulator, Flash, Artillery: M21 Ammunition Surveillance Procedure (DODAC 1370-L602).....	SB 742-1370-94-742
Simulator, Hand Grenade: M116A1 (1370-L601) Ammunition Surveillance Procedures	SB 742-1370-94-744
Flare, Surface, Trip: M49A1 (1360-L495) Ammunition Surveillance Procedure	SB 742-1370-94-760

A.7 SUPPLY CATALOGS.

SC 9999-01-SKO, Consolidated Publication of Component Lists	EM 0074
---	---------

A.8 TECHNICAL MANUALS.

Army Ammunition Data Sheets for Military Pyrotechnics (Federal Supply Class 1370).....	TM 43-0001-37
Operator’s and Aviation Unit Maintenance Manual (Including Repair Parts and Special Tools List) for Dispenser, General Purpose Aircraft: M130	TM 9-1095-206-12&P
Aviation Intermediate Maintenance Manual (Including Repair Parts and Special Tools List) for Dispenser, General Purpose Aircraft: M130	TM 9-1095-206-30&P
Ammunition Maintenance	TM 9-1300-250
Operator’s and Organizational Maintenance Manual (Including Repair Parts and Special Tools List) for Flare, Aircraft: Parachute, White, MK 45 Mod 0; Flare, Aircraft: Parachute, MK 45 Mod 0 with Adapter for Dispenser XM19 and Dispenser, Flare: XM19	TM 9-1370-201-12
Unit Maintenance Manual for Military Pyrotechnics	TM 9-1370-203-20
Operator’s Manual for Pyrotechnic Signals	TM 9-1370-206-10
Operator’s Manual for Pyrotechnic Simulators.....	TM 9-1370-207-10
Operator’s Manual for Photoflash Cartridges, Surface Flares and Miscellaneous Pyrotechnic Items	TM 9-1370-208-10

THIS PAGE INTENTIONALLY LEFT BLANK

**APPENDIX B
DIRECT SUPPORT AND GENERAL SUPPORT
PACKING MATERIALS, ACCESSORIES, AND TOOLS**

SECTION I. INTRODUCTION

B.1 SCOPE.

This appendix lists packing materials, accessories, and tools required for the performance of Direct Support and General Support maintenance of military pyrotechnics.

B.2 GENERAL.

This appendix is divided into the following sections:

B.2.1 Section II - Packing Materials and Accessories - A list of packing materials authorized for the performance of maintenance at the direct support and general support levels.

B.2.2 Section III - Special Packing Tools List - A list of special tools and accessories authorized for the performance of maintenance at the Direct Support and General Support.

B.3 EXPLANATION OF COLUMNS.

The following provides an explanation of columns in Section II and III.

B.3.1 Column (1). Part Number/Drawing Number (PART NO./DWG. NO.) - The primary number used by the manufacturer which controls the design and characteristics of the item. Drawings can be obtained from originating source (see CAGE Code).

B.3.2 Column (2). Contractor and Government Entity Code (CAGEC) - A five-digit code used to identify the manufacturer, distributor, or Government agency/activity that supplies the item.

B.3.3 Column (3). Figure Number - The number of the figure where the item is identified/located if applicable.

B.3.4 Column (4). Description - The Federal item name and any additional description of the item required.

SECTION II. PACKING MATERIALS AND ACCESSORIES

(1) PART NO./ DWG. NO.	(2) CAGE CODE	(3) FIGURE NO.	(4) DESCRIPTION
8860565	19203		<p style="text-align: center;">GROUP - 01 CARTRIDGES</p> <p style="text-align: center;">0101 - CARTRIDGES PHOTOFLASH</p> <p>BOX, PACKING, AMMUNITION: for CARTRIDGES, PHOTOFLASH, M112A1, M143 or Practice, M121.</p>
7548473	19203		<p>BOX, PACKING, AMMUNITION: for CARTRIDGE, PHOTOFLASH: M123A1 and Practice, M124.</p>
			<p style="text-align: center;">GROUP - 02 FLARES</p> <p style="text-align: center;">0201 - FLARE, SURFACE: TRIP</p> <p>8830880 19203</p> <p>BOX, PACKING, AMMUNITION: for FLARE, SURFACE: Trip, M49A1.</p>
2816267	30003		<p style="text-align: center;">0202 - FLARE, AIRCRAFT, M206</p> <p>PACKING, SHIPPING AND STORAGE: for 2 flares, Aircraft, parachute, Mk 45 Mod 0; Mk 45 Mod 1, w/ Adapter.</p>
9313718	19203		<p>BOX, PACKING, AMMUNITION: for FLARE, AIRCRAFT: Countermeasure, M206</p>
8865541	19203		<p>SHIPPING AND STORAGE CONTAINER: PA19 Assembly (Inner Pack)</p>
7553296	19200		<p style="text-align: center;">0203 - FLARE, BALLISTIC AERIAL TARGET: MK33</p> <p>CHEST, AMMUNITION: M2A1, Used for small arms, Various Fuzes, Grenades and Flares</p> <p>BOX, WIREBOUND: (use available or original packing material NSN has not been assigned)</p>
12988805	19200		<p style="text-align: center;">0204 - FLARE, AIRCRAFT, M211</p> <p>PACKING, SHIPPING AND STORAGE: PA19 for 36 Flares, Aircraft Countermeasure, M211</p>
12988808	19200		<p>BOX, PACKING INSTRUCTIONS: Wirebound box, for Flare, Aircraft Countermeasure, M211</p>
12988844	19200		<p style="text-align: center;">0205 - FLARE, AIRCRAFT, M212</p> <p>BOX, PACKING, AMMUNITION: PA 19 for 50 Flares, Aircraft Countermeasure, M212</p>

SECTION II. PACKING MATERIALS AND ACCESSORIES (Continued)

(1) PART NO./ DWG. NO.	(2) CAGE CODE	(3) FIGURE NO.	(4) DESCRIPTION
12988845	19200		BOX, WIREBOUND: for Flare, Aircraft Countermeasure, M212
12988846	19200		BOX, PACKING: for Unit Load M212 Flare, Aircraft, Countermeasure
			<p style="text-align: center;">GROUP - 03 SIGNALS 0301 - SIGNAL, ILLUMINATION, AIRCRAFT</p>
8836950	19203		<p>BOX, PACKING, AMMUNITION: for SIGNALS, ILLUMINATION, AIRCRAFT: Double Star, AN-M37A2 through AN-M41A2; Single Star, AN-M43A2 through AN-M45A2; Colored Tracer, Double Star, AN-M53A2 through AN/M57A2.</p>
			<p style="text-align: center;">0302 - SIGNAL KITS, PERSONNEL, DISTRESS</p>
9231551	19203		<p>BOX, PACKING, AMMUNITION: for SIGNAL KITS, PERSONNEL, DISTRESS: M185 and M186</p>
			<p style="text-align: center;">0303 - SIGNAL, ILLUMINATION</p>
9234287	19203		<p>BOX, PACKING, AMMUNITION: for SIGNALS, ILLUMINATION, GROUND: M186, M187, M188, M189, M190.</p>
			<p style="text-align: center;">0304 - SIGNALS, ILLUMINATION AND SMOKE</p>
7548415	19203		<p>BOX, PACKING, AMMUNITION: for SIGNALS, ILLUMINATION, GROUND: Cluster, M125A1, M158, M159; GROUND: Parachute, M126A1, M127A1, M195; SIGNALS, SMOKE, GROUND: Parachute, M128A1, M129A1, M194.</p>
7258943	19201		<p>SHIPPING AND STORAGE CONTAINER, CARTRIDGE: M548</p>
12900007	19200		<p>PACKING, PREFORMED: Used for container PA142</p>
			<p style="text-align: center;">0305 - SIGNALS, ILLUMINATION, GROUND</p>
8837837	19203		<p>BOX, PACKING, AMMUNITION: for SIGNAL, ILLUMINATION: Parachute, M131.</p>

SECTION II. PACKING MATERIALS AND ACCESSORIES (Continued)

(1) PART NO./ DWG. NO.	(2) CAGE CODE	(3) FIGURE NO.	(4) DESCRIPTION
			<p>0306 - SIGNALS, ILLUMINATION AND SMOKE, GROUND</p> <p>BOX, PACKING, AMMUNITION: for SIGNALS, ILLUMINATION, GROUND: (Use available or original packing material - NSN has not been assigned)</p>
563246	10001		<p>0307 SIGNAL, ILLUMINATION, MARINE</p> <p>0308- SIGNAL, SMOKE AND ILLUMINATION, MARINE</p> <p>BOX, AMMUNITION: for SIGNAL, SMOKE AND ILLUMINATION, MARINE: Mk13 Mod 0.</p>
9210950	19203		<p>0309 - SIGNAL, SMOKE GROUND</p> <p>BOX, PACKING, AMMUNITION: for SIGNALS, SMOKE, GROUND: XM166, M167, M168, and M169.</p>
89108839	98747		<p>0310 - SIGNAL KITS, PERSONNEL DISTRESS</p> <p>BOX, PACKING AMMUNITION: for SIGNAL KITS, PERSONNEL DISTRESS: FOLIAGE PENETRATING (RED DODIC L119).</p>
8853678	19203		<p>GROUP - 04 SIMULATORS</p> <p>0401 -SIMULATOR, ATOMIC EXPLOSION</p> <p>0402 -SIMULATOR, ATOMIC EXPLOSION</p> <p>BOX, PACKING, AMMUNITION: for DETONATION SIMULATOR, EXPLOSIVE: M80.</p>
8799712	19203		<p>0403 - SIMULATORS, BOOBY TRAP</p> <p>BOX, PACKING, AMMUNITION: for SIMULATORS, BOOBY TRAP: Flasher M117; Illuminating M118.</p>
8799717	19203		<p>BOX, PACKING, AMMUNITION: for SIMULATOR, BOOBY TRAP: M119.</p>
8880486	19203		<p>0404 - SIMULATOR, FLASH ARTILLERY</p> <p>BOX, PACKING, AMMUNITION: for SIMULATOR, FLASH, ARTILLERY: M110.</p>

SECTION II. PACKING MATERIALS AND ACCESSORIES (Continued)

(1) PART NO./ DWG. NO.	(2) CAGE CODE	(3) FIGURE NO.	(4) DESCRIPTION
8799715	19203		0405 - SIMULATOR, HAND GRENADE BOX, PACKING, AMMUNITION: for SIMULATOR, HAND GRENADE: M116A1.
8860597	19203		0406 - SIMULATOR, PROJECTILE AIRBURST: M27A1B1 BOX, PACKING AMMUNITION: for SIMULATOR, PROJEC- TILE AIRBURST.
8836950	19203		0407 - SIMULATOR, PROJECTILE AIRBURST: M74A1, M74 BOX, PACKING, AMMUNITION: for SIMULATORS, PRO- JECTILE AIRBURST: M74A1.
20-4072	81361		0408 - SIMULATOR, PROJECTILE AIRBURST: CHARGE, SMOKE PUFF, WHITE BOX, PACKING, AMMUNITION: for SIMULATOR, PRO- JECTILE AIRBURST: Charge, Smoke Puff, White.
8799710	19203		0409 - SIMULATOR, PROJECTILE GROUND- BURST: M115A2 BOX, PACKING, AMMUNITION: for SIMULATOR, PRO- JECTILE GROUNDBURST: M115A2.
9342971	19203		0410 - SIMULATOR, FLASH, ARTILLERY BOX, PACKING, AMMUNITION: for SIMULATOR, FLASH, ARTILLERY: M21.
9344296	19200		0411 - SIMULATOR, PYROTECHNIC BOX, PACKING, AMMUNITION: for SIMULATOR, PYRO- TECHNIC, CTG 50MM: M800.
12975499	19200		0412 - SIMULATOR, LAUNCHING, ANTI-TANK GUIDED MISSILE AND ROCKET, M22 PACKING AND MARKING FOR BOX, PACKING, WOOD: for SIMULATOR, LAUNCHING, AT, GM & RKT, M22.
12978485	19200		0413 - SIMULATOR, TANK, MAIN GUN FIRE BOX, PACKING, AMMUNITION: for SIMULATOR, AVCPS, MGSS, M30.
			0414 - SIMULATOR, DIFCUE BOX, PACKING, AMMUNITION: for SIMULATOR, AVCPS, MGSS, M31A1.

SECTION II. PACKING MATERIALS AND ACCESSORIES (Continued)

(1) PART NO./ DWG. NO.	(2) CAGE CODE	(3) FIGURE NO.	(4) DESCRIPTION
12598324	19200		0415 - SIMULATOR, M27, SAGGER BOX, PACKING, AMMUNITION: for SIMULATOR, ANTI-TANK GUIDED MISSILE SIGNATURE: M27.
12972824	19200		0416 - SIMULATOR, TARGET HIT, M25 BOX, PACKING, AMMUNITION: for SIMULATOR, TARGET HIT, M25.
12972823	19200		BOX, FIBERBOARD: for SIMULATOR, TARGET HIT, M25.
9395638	19200		0417 - SIMULATOR, TARGET KILL, M26 BOX, PACKING, AMMUNITION: for SIMULATOR, TARGET KILL, M26.
9395639	19200		BOX, FIBERBOARD: for SIMULATOR, TARGET KILL, M26.
C.000760.01	1PRS3		0418 - SIMULATOR, HOSTILE FIRE, M34 INNER BOX, UNIT: for SIMULATOR M34.
C.000764.01	1PRS3		INTERMEDIATE BOX: for SIMULATOR M34.
C.000767	1PRS3		OUTER BOX, WIREBOUND: for SIMULATOR M34.
C.000760.01	1PRS3		0419 - SIMULATOR, TARGET HIT, WHITE STAR, M35 INNER BOX, UNIT: for SIMULATOR M35.
C.000764.01	1PRS3		INTERMEDIATE BOX: for SIMULATOR M35.
C.000767	1PRS3		OUTER BOX, WIREBOUND: for SIMULATOR M35.
			GROUP - 05 MISCELLANEOUS PYROTECHNICS
9227606	19203		0501 - FUSEE, WARNING, RAILROAD SUPPORT TOP: for FUSEE, WARNING RAILROAD: M72.
9224975	19203		0502 - MARKER, LOCATION, MARINE DYE, AN-M59 BOX, PACKING, AMMUNITION: for MARKER, LOCATION, MARINE: Dye, AN-M59. (Use available or original packing material - NSN has not been assigned.)
C4-1-14	81361		0503 - STARTER, FIRE: M2 STARTER, FIRE ASSEMBLY: M2.

SECTION III. SPECIAL PACKING TOOLS LIST

(1) PART NO./ DWG. NO.	(2) CAGE CODE	(3) FIGURE NO.	(4) DESCRIPTION
15-SS	17987		BRUSH: 3/8 in. x 1 3/8 in. ¹ (7920-00-900-3577)
GSAPD 8020-00-224-8010 ITEM 9	80244		BRUSH, ARTIST'S: A7 Flat, chisel edge (8020-00-240-6361)
GSAPD 8020-00-224-8010 ITEM 12	80244		BRUSH, ARTIST'S: A1 Round, flat edge ¹ (8020-00-246-8504)
B-82-2017	61452		BRUSH, WIRE, SCRATCH: Beryllium copper alloy, D7 curved handle, 5.750 in. minimum and 6 in. maximum brush part length ¹ (7920-00-255-5135)
B-80-2015	61452		BRUSH, WIRE, SCRATCH: Beryllium copper alloy, D4 block handle straight rectangular face ¹ (7920-00-269-0933)
GSAPD 8020-00-245-4517	80244		BRUSH, PAINT: 1 1/2 in. nom w x 13/32 in nom thick, flat ¹ (8020-00-889-7919)
A-A-1674	58536		CAN, FLAMMABLE WASTE: 6 gl. cap., foot operated cover, No. 11105 (7240-00-282-8411)
237B	49234		CAN, PLUNGER FLAMMABLE LIQUID: Safety, 1/4 gl. cap., 2 in. dia screen (4940-00-633-9670)
53M34750	11722		MARKING OUTFIT: Rubber, solid Gothic type, unmounted lock type 1/4, 1/2, 3/4, or 1-in. Letters (7520-00-049-7993) ²
GGG-M-125/6	81348		RESPIRATOR, AIR FILTERING. Elastic, medium size **use until exhausted - AAC = Y (4240-00-022-2524)
8864731	19203		SALEE CLOSER: stl, 8-5/16 in. oa lg, 20 degree angle blade with 12 teeth ¹ (5120-00-319-5434)

SECTION III. SPECIAL PACKING TOOLS LIST (Continued)

(1) PART NO./ DWG. NO.	(2) CAGE CODE	(3) FIGURE NO.	(4) DESCRIPTION
A-A-52215	58536 +		<p>STRAPPING AND SEALING KIT:¹ (3540-00-565-6242) Consisting of the following: Sealer, steel strapping, hand: 3540-00-234-6742, qty 1 Stretcher, steel strapping, hand: 3540-00-278-1250, qty 1 Box, wood: 8115-00-897-5516, qty 1 Seal, strapping: 8135-00-290-1086, qty 1600 Strapping, steel: 8135-00-283-0667, qty 1 90 LB coil</p>
MIL-S-43104 TY5	80244		<p>STRAPPING AND SEALING KIT:² (3540-00-565-6244) Consisting of the following: Sealer, steel strapping, hand: 3540-00-223-8592, qty 1 Stretcher, steel strapping, hand: 3540-00-278-1251, qty 1 Cutter, steel strapping, hand: 5110-00-223-6281, qty 1 Box, wood: 8115-00-239-5294, qty 1 Seals strapping: 8135-00-239-5294, qty 100 Strapping, steel: 8135-00-283-0671, qty 1 90 LB coil</p>

¹ Item is currently being processed for inclusion in EM 0074 for Direct Support Maintenance.

² Item is listed in EM 0074 for General Support Maintenance.

**APPENDIX C
EXPENDABLE AND DURABLE ITEMS LIST**

SECTION I. INTRODUCTION

C.1 SCOPE.

C.1.1 This appendix lists expendable and durable items which are required for Direct Support and General Support maintenance of Military Pyrotechnic.

C.1.2 Expendable supplies shall be requisitioned through normal supply channels to comply with maintenance requirements.

C.2 EXPLANATION OF COLUMNS.

C.2.1 Column 1. Item number. This number is assigned to the entry in the listing for referencing when required.

C.2.2 Column 2. Level. The column identifies the lowest level of maintenance that requires the item.

O - Unit Maintenance
F - Direct Support Maintenance
H - General Support Maintenance

C.2.3 Column 3. National Stock Number. This is the National Stock Number (NSN) assigned to the item; use it to request or requisition the item.

C.2.4 Column 4. Description. This indicates the federal item name and if required a description to identify the item. The last line of each item indicates the Commercial and Government Entity Code (CAGE) parenthesis followed by the part number.

C.2.5 Column 5. Unit of measure (UM) /Unit of Issue (U). This measure is expressed by a two character alphabetical abbreviation (e.g., EA, IN, PR). If the unit of measure differs from the unit of issue as in the Army Master Data File (AMDF) requisition the lowest unit of issue that will satisfy your requirements.

SECTION II. EXPENDABLE AND DURABLE ITEMS LIST

(1) Item Number	(2) Level	(3) National Stock Number	(4) Description	(5) (U/M)/ (U/l)
1	O	6810-00-184-4796	ACETONE, TECHNICAL: liquid (81348) O-A-51	cn
2	O	6810-00-543-7415	ALCOHOL, DENATURED: liquid, grade III (81348) OE760	gl
3	O	6850-00-174-9672	CORROSION REMOVING COMPOUND: liquid, type II (81349) MILC10578	gl
4	O	7930-00-249-8036	DETERGENT GENERAL PURPOSE: flake or powder, 51b box or can (58536) A-A-1376	co
5	O	8010-00-910-8154	ENAMEL: black, No. 37038, lusterless (81348) TT-E-516	pt
6	O	8010-00-848-9272	ENAMEL: olive drab, No. 34088, lusterless (81348) TT-E-526	pt
7	O	8010-00-878-5761	ENAMEL: white, No. 37875, lusterless (81348) TT-E-516	pt
8	O	8010-00-878-5525	ENAMEL: yellow, No. 23538, semigloss (81349) MIL-E-16663	pt
9	O	8010-00-297-2120	ENAMEL: gray, No. 36231, lusterless (81348) TT-E-516	gl
10	O	8010-00-297-2119	ENAMEL: medium blue, No. 35109, lusterless (81348) TT-E-516	gl
11	O	8010-00-297-2122	ENAMEL: black, No. 37038, lusterless (81348) TT-E-516	gl
12	O	8010-00-828-3193	ENAMEL: light green, No. 34558, lusterless (81348) TT-E-516	gl
13	O	8010-00-297-2116	ENAMEL: olive drab, No. 34088, lusterless (96906) MS35527-8	gl
14	O	8010-01-088-0096	ENAMEL: orange No. 32246, lusterless (81348) TT-E-515	qt
15	O	8010-00-577-4937	ENAMEL: red, No. 31168, lusterless (81348) TT-E-516	qt

(1) Item Number	(2) Level	(3) National Stock Number	(4) Description	(5) (U/M)/ (U/I)
16	O	8010-00-297-2112	ENAMEL: yellow, No. 33538, lusterless (81348) TT-E-516	gl
17	O	8010-00-297-2111	ENAMEL: white, No. 37875, lusterless (81348) TT-E-516	gl
18	O	5315-00-597-9766	FASTENER, CORRUGATED, WOOD JOINT: sawtooth 1/2 in. w (58536) A-A-1957	hd
19	O	8415-00-682-6786	GLOVES: disposable, plastic	pr
20	O	8520-00-782-3509	HAND CLEANER: paste, fits dispenser (NSN 4520-00-919-1217) (10266) DD10	cn
21	O	7510-00-161-0811	INK, MARKING, STENCIL: black, No. 37038 (58536) A-A-208	gl
22	O	7510-00-161-0815	INK, MARKING, STENCIL: white, No. 37875 (58536) A-A-208	gl
23	O	7510-00-161-0816	INK, MARKING, STENCIL: yellow, No. 33538, weather resistant (58536) A-A-208	gl
24	O	7520-00-558-1487	MARKER, TUBE TYPE: white, permanent ink, felt tip (58536) A-A-356	oz
25	O	7520-00-973-1059	MARKER, TUBE TYPE: black, permanent ink, felt tip (81348) GG-M-00114	dz
26	O	7520-00-973-1062	MARKER, TUBE TYPE: red, permanent ink, felt tip (81348) GG-M-001144	dz
27	O	5315-00-889-2743	NAIL: size 4, type II, 6d, 1-1/2 in. fastener lg (81348) FF-N-105	pg
28	O	5315-00-889-2744	NAIL: style 4A, type II, 6d, 2 in. fastener lg (81348) FF-N-105	pg

(1) Item Number	(2) Level	(3) National Stock Number	(4) Description	(5) (U/M)/ (U/I)
29	O	5350-00-271-7935	PAPER, ABRASIVE: flint, gr 2/0 1/2 x 6 style 4, type A, 8d, 2-11/2 in. pound, open coat, gr 1.2.2, class 1, 100 sheets (81348) PNAA-1201	pg
30	O	7920-00-205-1711	RAG, WIPING: cotton, unbleached, mixed colors (64067) 7920-00-205-1711	be
31	O	5340-00-491-7632	SEAL, ANTIPIILFERAGE: 1/2 in. dia, (96906) MS 51938-5	ea
32	O	8135-00-239-5291	SEAL, STRAPPING: for 5/8 in. w. (81346) ASTM D 3953-67	bx
33	O	8135-00-239-5294	SEAL, STRAPPING: for 1-1/4 in. w. (81346) ASTM D 3953-87	bx
34	O	9310-00-2404737	STENCILBOARD: oiled, 18-1/2 in. w, x 18-1/2 in. long	sh
35	O	8135-00-281-4071	STRAPPING: steel, 5/8 in. w (81346) ASTM D 3953-87	cl
36	O	8135-00-283-0671	STRAPPING: steel, 1-1/4 in. w (81346) ASTM D 3953-87	cl
37	O	7510-00-266-6712	TAPE, PRESSURE SENSITIVE ADHESIVE: one side, tan, masking, crepe back, 1 in. wide, 60 yds lg (19203) 8783476	ro
38	O	7510-00-823-8073	TAPE, PRESSURE SENSITIVE ADHESIVE: one side, black, 1-1/2 in. wide (for fiber container) (81349) MIL-T43036	ro
39	O	7510-00-266-6710	TAPE, PRESSURE SENSITIVE ADHESIVE: one side, tan, masking, crepe back, 2 in. wide (18820) 802563	ro
40	O	7520-00-266-6711	TAPE, PRESSURE SENSITIVE ADHESIVE: one side, tan, masking, crepe back, 3/4 in. w (52152) 232 3/4 in.	ro

(1) Item Number	(2) Level	(3) National Stock Number	(4) Description	(5) (U/M)/ (U/l)
41	O	7510-00-266-5016	TAPE, PRESSURE SENSITIVE ADHESIVE: one side, olive drab cotton and linen, water resistant, 2 in. w (81348) PPP-T-60	ro
42	O	8010-00-160-5788	THINNER, PAINT PRODUCT: (58536) A-A-857	cn
43	O	8010-00-242-2089	THINNER, PAINT PRODUCT: (81348) TT-T-291	gl
44	O	8010-00-160-5794	THINNER, PAINT PRODUCT: (96906) ms35628-2	gl

THIS PAGE INTENTIONALLY LEFT BLANK

**APPENDIX D
PACKING, MARKING AND STORAGE DATA**

SECTION I. INTRODUCTION

D.1 SCOPE.

This appendix contains information required by Direct Support and General Support of maintenance for repacking of military pyrotechnics.

D.2 EXPLANATION OF COLUMNS.

D.2.1 Item. Column 1 indicates the nomenclature of the military pyrotechnics.

D.2.2 DODIC. Column 2 indicates the Department of Defense Identification Code, assigned to the general description within the Federal Supply (Class for Military pyrotechnics).

D.2.3 Inner Pack Column 3 indicates the type of pack. Alpha legend is explained at end of appendix.

D.2.4 Number of Items Per Inner Pack Column 4 indicates the quantity of items per inner pack.

D.2.5 Outer Pack Column 5 indicates type of package. Alpha legend is explained at end of appendix.

D.2.6 Number of Items per Outer Pack Column 6 indicates the quantity of munitions in the outer pack.

D.2.7 Number of Inner Packs per Outer Pack Column 7 indicates the quantity of inner packs per outer pack.

D.2.8 Arrangement of Inner Packs per Outer Pack Column 8 indicates the quantity of inner packs as arranged in the boxes.

D.2.8 Total Weight (lbs). Column 9 indicates total weight of the outer and inner pack and contents.

D.2.9 Total Explosives Weight (lbs). (Column 10 indicates the total weight of explosives of the packaged military pyrotechnics.

D.2.10 Cube. Column 11 indicates result of the length, multiplied by the width, multiplied by height of the outer pack.

D.2.11 Number of Outer Packs per Pallet. Column 12 indicates the quantity of boxes placed on a pallet.

D.2.12 Arrangement of Outer Packs per Pallet. Column 13 indicates the quantity of boxes as arranged on the pallet.

D.2.13 Quantity Distance Class. Column 14 indicates the class assigned to military pyrotechnics in accordance with the quantity of explosives, materials and the distance separation relationship which provide defined types of protection. These relationships are based on levels of risk considered acceptable for the stipulated exposures.

D.2.14 Storage Compatibility Group. Column 15 indicates the group assigned to military pyrotechnics over-seas. The relationship between different items of ammunition, explosives and other dangerous materials whose characteristics are such that a quantity of two or more of the items stored or transported together is no more hazardous.

D.2.15 Footnote. Explanation is at the end of this appendix.

D.3 DEPARTMENT OF TRANSPORTATION (DOT) CLASSIFICATION MARKING.

D.3.1 General. DOT classification marking is specified on the outer package. DOT marking for all military pyrotechnics except those listed below is "SPECIAL FIREWORKS-HANDLE CAREFULLY-KEEP FIRE AWAY".

D.3.2 Cartridges. Photoflash: M112A1 and M123A1. DOT classification marking for M112AI and M123AI photoflash cartridges is "EXPLOSIVE BOMBS".

D.3.3 Flare, Dispenser: XM19. DOT classification marking for XM19 dispenser flare is "BOMB, RACK, AIRPLANE".

D.3.4 Marker. Location. Marine: Dye, AN-59. DOT classification marking for AN-M59 dye marine location marker is "MARKER, AMMUNITION, NONEXPLOSIVE".

D.3.5 Simulator. Atomic Explosion. M142. DOT classification marking for M142 atomic explosion simulator is "EXPLOSIVE BOMB".

D.4 MARKING DATA.

Refer to figures 4-1 through 4-10 for required marking data.

SECTION II. PACKING, MARKING AND STORAGE DATA

(1) Item	(2) Dept. of Defense identification code (DODIC)	(3) Inner pack	(4) No. items per inner pack	(5) Outer pack	(6) No. items per outer pack	(7) No. inner packs per outer pack	(8) Arrangement of inner packs in outer pack	(9) Total weigh (lb) ¹	(10) Total explosive weight (lb)	(11) Cube (ft) ¹	(12) No. outer pack per pallet	(13) Arrangement of outer packs on pallet	(14) Quantity dis- tance class	(15) Storage compati- bility group
CARTRIDGE, PHOTOFLASH: M122A1, 1-second delay 2-second delay 4-second delay	L135 L136 L137	a	10	p	40	4	1 x 4 1 layer	75	17.7	1.5	32	2 x 4 2 layers	7	Q
CARTRIDGE, PHOTOFLASH: M123A1, 2-second delay 4-second delay 6-second	L139 L140 L141	b	3	p	12	4	1 x 4 1 layer	74.4	18.8	1.7	24	2 x 4 3 layers	2	Q
CARTRIDGE, PHOTOFLASH: Practice, M121	L138	b	10	p	40	4	1 x 4 1 layer	75	0.20	1.5	32	2 x 4 4 layers	2	N
M124	L142	b	3	p	12	4	1 x 4 1 layer	74.4	0.16	1.7	24	2 x4 3 layers	2	N
DISPENSER, FLARE: XM19	L106	--	--	q	1	--	--	3.62	None	51.3	--	--	1	B,E,N,
FLARE, AIRCRAFT: , Parachute, Mk45 Mod O	L473	--	--	r	2	--	--	59.4	35.6	2.39	24	1 x 4 6 layers	2	N
Parachute, Mk45 Mod O w/adapter	L424	--	--	r	2	--	--	61.0	35.6	2.39	24	6 layers	2	N
Countermeasure, M206	L410	f	50	p	100	2	--	67.0	30.3	1.30	36	3 x 4 3 layers	1.3	G or S
Countermeasure, M211	LA14	f	36	u	72	2	-	92	38.1	1.3	27	3 x 3 3 layers	4.2	G
Countermeasure, M212	LA15	f	50	u	100	2	-	75	24.3	1.3	27	3 x 3 3 layers	1.3	G

SECTION II. PACKING, MARKING AND STORAGE DATA (Continued)

(1) Item	(2) Dept. of Defense identification code (DODIC)	(3) Inner pack	(4) No. items per inner pack	(5) Outer pack	(6) No. items per outer pack	(7) No. inner packs per outer pack	(8) Arrangement of inner packs in outer pack	(9) Total weigh (lb) ¹	(10) Total explosive weight (lb)	(11) Cube (ft) ¹	(12) No outer packl per pallet	(13) Arrangement of outer packs on pallet	(14) Quantity dis- tance class	(15) Store compati- bility group
SURFACE: Airport M76 Airport M76	L425 L425	b	1	p	1	1	--	42	20.5	1	--	--	2	N
Trip M49A1	L495	c	32	p	32	1	--	46.5	8.85	1.74	27	3 x 3 3 layers	2	N
SIGNALS ILLUMINATION, AIRCRAFT: Double star, Red-Red AN-M38A22	L225	d	1-	p	80	8	2 x 4 1 layer	57.5	19.3	1.6	32	2 x 4 4 layers	2	N
Yellow-Yellow, AN-M38A2	L226	d	10	p	80	8	2 x 4 1 layer	57.5	19.3	1.6	32	2 x 4 2 layers	2	N
Green-Green, AN-M39A2	L227	d	10	p	80	8	2 x 4 1 layer	57.5	20.3	1.6	32	2 x 4 4 layers	2	N
SIGNALS ILLUMINATION, AIRCRAFT Red-Yellow, AN-M40A2	L228	d	10	p	80	8	2 x 4 1 layer	57.5	20.3	1.6	32	2 x 4 layers	2	N
Red-Green, AN-M41A2	L229	d	10	p	80	8	2 x 4 1 layer	57.5	20.3	1.6	32	2 x 4 4 layers	2	N
Single Star, Red, AN-M43A2	L231	d	1-	p	80	8	2 x 4 1 layer	57.5	10.3	1.6	32	2 x 4 4 layers	2	N
Yellow, AN-M44A2	L332	d	10	p	80	8	2 x 4 1 layer	57.5	12.2	1.6	32	2 x 6 4 layers	2	N

SECTION II. PACKING, MARKING AND STORAGE DATA (Continued)

(1) Item	(2) Dept. of Defense identification code (DODIC)	(3) Inner pack	(4) No. items per inner pack	(5) Outer pack	(6) No. items per outer pack	(7) No. inner packs per outer pack	(8) Arrangement of inner packs in outer pack	(9) Total weigh (lb) ¹	(10) Total explosive weight (lb)	(11) Cube (ft) ¹	(12) No outer pack per pallet	(13) Arrangement of outer packs on pallet	(14) Quantity dis- tance class	(15) Storate compati- bility group
Green, AN-M45A2	L233	D	10	p	80	8	2 x 4 1 layer	57.5	10.3	1.6	32	2 x 4 4 layers	2	N
Yellow Tracer, Double Star, Red-Yellow, AN-M54A2	L234	d	10	p	80	8	2 x 4 1 layer	57.5	8.85	1.6	32	2 x 4 4 layers	2	N
Green Tracer, Double Star, Red-Red. AN-M54A2	L235	d	1-	p	80	8	2 x 4 1 layer	57.5	8.85	1.6	32	2 x 4 4 layers	2	N
Green-Red, AN-M55A2	L236	d	10	p	80	8	2 x 4 1 layer	57.5	8.85	1.6	32	2 x 4 4 layers	2	N
Red Tracer, DoubleStar, Green-Green, Red-Red AN-M56A2	L237	d	10	p	80	8	2 x 4 1 layer	57.5	8.85	1.6	32	2 x 4 4 layers	2	N
Red-Red AN-M57A2	L238	d	10	p	80	8	2 x 4 1 layer	57.5	8.85	1.6	32	2 x 4 4 layers	2	N
KIT, PERSONNEL: Red, M185	L116	b	60	p	240	4	2 x 2 1 layer	135	22.2	5.7	--	--	2	N
Various Colors M186	1117	B	60	P	240	4	2 X 2 1 layer	135	22.2	5.7	--	--	2	N
Red, Foliage Penetrating	L119	d	1	p	100	100	--	90	3.13	8.0	--	--	1,3	G
ILLUMINATION, GROUND Red, M187	L278	e	50	p	1,250	25	5 x 5 1 layer	81	16.5	2.1	--	--	2	N

SECTION II. PACKING, MARKING AND STORAGE DATA (Continued)

(1) Item	(2) Dept. of Defense identification code (DODIC)	(3) Inner pack	(4) No. items per inner pack	(5) Outer pack	(6) No. items per outer pack	(7) No. inner packs per outer pack	(8) Arrangement of inner packs in outer pack	(9) Total weigh (lb) ¹	(10) Total explosive weight (lb)	(11) Cube (ft) ¹	(12) No outer packl per pallet	(13) Arrangement of outer packs on pallet	(14) Quantity dis- tance class	(15) Store compati- bility group
White, M188	L279	e	50	p	1,250	25	5 x 5 1 layer	81	16.5	2.1	--	--	2	N
Green, M189	L280	e	50	p	1,250	25	5 x 5 1 layer	81	16.5	2.1	--	--	2	N
Amber, M190	L281	e	50	p	1,250	25	5 x 5 1 layer	81	16.5	2.1	--	--	2	N
Green Star, Cluster, M125A1	L314	f	1	p	36	36	6 x 6 1 layer	55	9.7	1.5	27	3 x 3 3 layers	2	N
Red Star, Cluster, M158	L306	f	1	p	36	36	6 x 6 1 layer	55	8.8	1.5	27	3 x 3 3 layers	2	N
White Star, Cluster, M159	L307	f	1	p	36	36	6 x 6 1 layer	55	11.6	1.5	27	3 x 3 1 layer	2	N
Red Star Parachute, M126A1	L311	f	1	p	36	36	6 x 6 1 layer	55	10.4	1.5	27	3 x 3 3 layers	2	N
White Star Parachute, M127A1	L312	f	1	p	36	36	6 x 6 1 layer	55	10.4	1.4	27	3 x 3 3 layers	2	N
Green Star Parachute, M195	L305	f	1	p	36	36	6 x 6 1 layer	55	10.9	1.5	27	3 x 3 1 layer	2	N
Red Star, Distress, Parachute M131	L277	f	1	p	25	25	5 x 5 1 layer	50	8.6	1.2	--	--	2	N

SECTION II. PACKING, MARKING AND STORAGE DATA (Continued)

(1) Item	(2) Dept. of Defense identification code (DODIC)	(3) Inner pack	(4) No. items per inner pack	(5) Outer pack	(6) No. items per outer pack	(7) No. inner packs per outer pack	(8) Arrangement of inner packs in outer pack	(9) Total weigh (lb) ¹	(10) Total explosive weight (lb)	(11) Cube (ft) ¹	(12) No. outer pack per pallet	(13) Arrangement of outer packs on pallet	(14) Quantity dis- tance class	(15) Storage compati- bility group
Green Star, Parachute, M19A2	L310	g	1	p	30	30	5 x 6 1 layer	62	6.8	1.8	24	3 x 4 2 layers	2	N
ILLUMINATION, MARINE: Two Star, Red, AN-M75	L276	f	5	p	100	20	2 x 5 2 layers	57	2.6	1.68	--	--	2	N
SIMULATORS Booby Trap: Flash, M117	L598	k	5	p	150	30	2 x 3 5 layers	47	0.83	1.5	20	2 x 2 5 layers	2	N
Booby Trap: Illuminating, M118	L599	k	5	p	150	30	2 x 3 5 layers	47	1.66	1.5	32	4 x 4 2 layers	2	N
Booby Trap: Whistling, M119	L600	k	5	p	150	30	2 x 2 5 layers	47	1.16	1.5	--	--	2	N
Flash, Artillery: M110	L596	l	1	p	30	30	5 x 6 1 layer	55	3.95	1.8	40	2 x 4 5 layers	1.3	G
Pyrotechnic Ctg 50mm: M800	L602	l	9	p	162	18	3 x 6 1 layer	94.6	1.53	4.34	8	2 x 4 2 layers	1.3	G
Hand Grenade: M116A1	L601	m	5	p	150	30	2 x 4 3 layers	70	12.5	3.1	278	2 x 3 3 layers	7	Q
Projectile Airburst: M27A1B1	L351	b	9	p	36	4	---	51.3	5.25	2.28	24	2 x 4 3 layers	2	N
Projectile Airburst: M74A1 or M74	L366	b	10	p	80	8	2 x 4 1 layer	57.5	10.5	1.6	32	2 x 4 4 layers	2	N
Projectile, Airburst: Charge, Smoke Puff, White	L373	n	5	p	200	40	--	79	25	2.48	24	2 x 3 4 layers	7	Q
Tank Main, Signature M30	LA06	l	12	p	360	30	5 x 6	17.5	4.8	2.1	12	n/a	1.3	G
Tank Main, Signature M31A1	LA07	l	12	p	360	30	5 x 6	21.4	1.6	2.1	18	n/a	1.3	G
Antitank Guided Missile Signature: M27	L715	h	12	u	144	12	2 x 3 2 layers	478	111.14	83.9	1	--	1.3	G
Launching, Anti-Tank, Guided Missile and Rocket, M22	L367	b	10	p	240	24	2 x 3 4 layers	40	7.98	1.5	--	--	1.3	G

SECTION II. PACKING, MARKING AND STORAGE DATA (Continued)

(1) Item	(2) Dept. of Defense identification code (DODIC)	(3) Inner pack	(4) No. items per inner pack	(5) Outer pack	(6) No. items per outer pack	(7) No. inner packs per outer pack	(8) Arrangement of inner packs in outer pack	(9) Total weigh (lb) ¹	(10) Total explosive weight (lb)	(11) Cube (ft) ¹	(12) No. outer pack per pallet	(13) Arrangement of outer packs on pallet	(14) Quantity dis- tance class	(15) Storage compati- bility group
Primer, Percussion Cap	L130	i		p	10,000	--	--	-	--	--	18	3 x 3 2 layers	1.4	S
Projectile, Ground Burst: M115A2	L594	b	5	p	100	20	2 x 5 2 layers	67.35	14.2	3.8	12	2 x 3 2 layers	7	Q
Flash, Artillery, M21	L602	e	9	p	162	18	3 x 6 1 layer	94.6	21.38	4.34	--	--	1.4	G
Target Hit, M25	L709	e	9	p	162	18	3 x 6 1 layer	86	8.75	4.34	10	3 x 2 2 layers not uniform	1.3	G
Target Kill, M26	L720	e	30	p	60	2	2 x 1 1 layer	117	67.60	4.03	--	--	1.3	G
Hostile Fire, M34	LA54	e	12	u	216	18	3 x 2 3 layers	37	8.57	1.75	24	4 x 2 3 layers	1.4	G
Target Hit, White Star, M35	LA53	e	12	u	216	18	3 x 2 3 layers	39	11.47	1.75	24	4 x 2 3 layers	1.4	G
MISCELLANEOUS PYROTECHNICS														
Fusee, Warning, Railroad: M72: 10 min.	L506	b	10	p	40	4	1 x 4 1 layer	46	11.3	1.3	--	--	2	N
Fusee, Warning, Railroad: M72: 15 min.	L507	b	10	p	40	4	1 x 4 1 layer	46	18.3	1.3	--	--	2	N
Fusee, Warning, Railroad: M72: 20 min.	L508	b	10	p	40	4	1 x 4 1 layer	46	22.5	1.3	--	--	2	N
SMOKE AND ILLUMINATION MARINE: AN- Mk 13 MOD 0	L275	f	12	p	108	9		80	31.0	3.2	18	2 x 3 3 layers	2	N
SMOKE, GROUND: Red, M62	L320	g	1	p	30	30	5 x 6 1 layer	62	6.5	1.8	24	3 x 4 2 layers	2	N
Yellow, M64	L322	g	1	p	30	30	5 x 6 1 layer	62	6.5	1.8	24	3 x 4 2 layers	2	N

SECTION II. PACKING, MARKING AND STORAGE DATA (Continued)

(1) Item	(2) Dept. of Defense identification code (DODIC)	(3) Inner pack	(4) No. items per inner pack	(5) Outer pack	(6) No. items per outer pack	(7) No. inner packs per outer pack	(8) Arrangement of inner packs in outer pack	(9) Total weigh (lb) ¹	(10) Total explosive weight (lb)	(11) Cube (ft) ¹	(12) No outer packl per pallet	(13) Arrangement of outer packs on pallet	(14) Quantity dis- tance class	(15) Storage compati- bility group
Green, M65	L318	g	1	p	30	30	5 x 6 1 layer	62	7.9	1.8	24	3 x 4 2 layers	2	N
Violet, M66	L321	g	1	p	30	30	5 x 6 1 layer	62	7.9	1.8	24	3 x 4 2 layers	2	N
White, M166	L340	h	6	p	240	40	2 x 4 5 layers	56	15.9	1.2	36	3 x 3 4 layers	2	N
Green, M167	L341	h	6	p	240	40	2 x 4 5 layers	56	9.6	1.2	36	3 x 3 4 layers		N
Red, M168	L342	h	6	p	240	40	2 x 4 5 layers	56	10.6	1.2	36	3 x 3 4 layers	2	N
Yellow,	L343	h	6	p	240	40	2 x 4 5 layers	56	9.0	1.2	36	3 x 2 4 layers	2	N
Green, Parachute, M128A1	L324	f	1	p	36	36	6 x 6 1 layer	55	7.7.	1.5	27	3 x 3 3 layers	2	N
Red, Parachute, M194	L293	f	1	p	36	36	6 x 6 1 layer	55	8.75	1.5	27	3 x 3 layers	2	N
Yellow, Parachute, M194	L293	f	1	p	36	36	6 x 6 1 layer	55	8.75	1.5	27	3 x 3 3 layers	2	N
SIMULATORS, ATOMIC EXPLOSION: M142	L605	i		s	1			201	105	11.8	--	--	7	Q

SECTION II. PACKING, MARKING AND STORAGE DATA (Continued)

(1) Item	(2) Dept. of Defense identification code (DODIC)	(3) Inner pack	(4) No. items per inner pack	(5) Outer pack	(6) No. items per outer pack	(7) No. inner packs per outer pack	(8) Arrangement of inner packs in outer pack	(9) Total weigh (lb) ¹	(10) Total explosive weight (lb)	(11) Cube (ft) ¹	(12) No outer packl per pallet	(13) Arrangement of outer packs on pallet	(14) Quantity dis- tance class	(15) Storate compati- bility group
DETONATION SIMULATOR, EXPLO- SIVE: M80	L378	j	50	p	2,500	50	5 x 5 2 layers	68	16.5	3.8	12	2 x 2 3 layers	7	Q
MISCELLANEOUS PYROTECHNICS- continued MARKER, LOCATION, MARINE: Dye, AN-M59	L582	b	10	p	30	3	1 x 3 1 layer	70	None	4.4	--	--	--	--
STARTER, FIRE: M2	1621	o	10	p	500	--	--	35	5.3	1.12	--	2		N

¹ Values are nominal.

LEGEND for columns 3 and 5:

a --- lead-foil envelope/carton
 b --- carton
 c --- carton/waterproof bag-
 d --- waterproofed carton
 e --- paperboard box/barrier bag
 f --- metal container
 g --- fiber container
 h --- barrier bag
 i --- none
 j --- waterproof carton

k --- carton/sealed bag
 l --- fiberboard carton
 m --- paperboard carton
 n --- container
 o --- plastic bags
 p --- wood box
 q --- wood crate
 r --- plastic container
 s --- metal drum
 t --- metal box
 u --- wirebound box

By Order of the Secretary of the Army:

Official: 
JOEL B. HUDSON
Acting Administrative Assistant to the
Secretary of the Army
01644

DENNIS J. REIMER
General, United States Army
Chief of Staff

Distribution:

To be distributed in accordance with DA Form 12-40E. Block 0322 requirements for TM 9-1370- 203-34.

RECOMMENDED CHANGES TO PUBLICATIONS AND BLANK FORMS For use of this form, see AR 25-30; the proponent agency is ODISC4.						Use Part II (<i>reverse</i>) for Repair Parts and Special Tool Lists (RPSTL) and Supply Catalogs/Supply Manuals (SC/SM).	DATE	
TO: (<i>Forward to proponent of publication or form</i>) (<i>Include ZIP Code</i>)						FROM: (<i>Activity and location</i>) (<i>Include ZIP Code</i>)		
PART I - ALL PUBLICATIONS (EXCEPT RPSTL AND SC/SM) AND BLANK FORMS								
PUBLICATION/FORM NUMBER TM 9-1370-203-34						DATE 18 Jun 99	TITLE SOF Demo Kit, M303	
ITEM NO.	PAGE NO.	PARA-GRAPH	LINE NO.*	FIGURE NO.	TABLE NO.	RECOMMENDED CHANGES AND REASON <i>(Provide exact wording of recommended changes, if possible).</i>		
1	1-2	1.2.4				Change "Rock Island, IL 61201" to read "Aberdeen Proving Ground, MD 21010". Reason: Wrong Address.		
2	2-3			2-6		Add "LOCKWASHER" to the illustration. Reason: Missing from illustration.		
<i>* Reference to line numbers within the paragraph or subparagraph.</i>								
TYPED NAME, GRADE OR TITLE						TELEPHONE EXCHANGE/AUTOVON, PLUS EXTENSION		SIGNATURE

SAMPLE

This Page Intentionally Left Blank

RECOMMENDED CHANGES TO PUBLICATIONS AND BLANK FORMS For use of this form, see AR 25-30; the proponent agency is ODISC4.						Use Part II (reverse) for Repair Parts and Special Tool Lists (RPSTL) and Supply Catalogs/Supply Manuals (SC/SM).	DATE
TO: (Forward to proponent of publication or form) (Include ZIP Code) LRED (AMSRD-AAR-AIL-LS) U.S. Army RDECOM, ARDEC Picatinny, NJ 07806-5000						FROM: (Activity and location) (Include ZIP Code)	
PART I - ALL PUBLICATIONS (EXCEPT RPSTL AND SC/SM) AND BLANK FORMS							
PUBLICATION/FORM NUMBER TM 9-1370-203-34						DATE 5 March 1996	TITLE Maint Manual f/Military Pyrotechnics
ITEM NO.	PAGE NO.	PARA-GRAPH	LINE NO.*	FIGURE NO.	TABLE NO.	RECOMMENDED CHANGES AND REASON <i>(Provide exact wording of recommended changes, if possible).</i>	
<i>* Reference to line numbers within the paragraph or subparagraph.</i>							
TYPED NAME, GRADE OR TITLE				TELEPHONE EXCHANGE/AUTOVON, PLUS EXTENSION		SIGNATURE	

TO: <i>(Forward direct to addressee listed in publication)</i> LRED (AMSRD-AAR-AIL-LS) U.S. Army RDECOM, ARDEC Picatinny, NJ 07806-5000	FROM: <i>(Activity and location) (Include ZIP Code)</i>	DATE
--	--	-------------

PART II - REPAIR PARTS AND SPECIAL TOOL LISTS AND SUPPLY CATALOGS/SUPPLY MANUALS

PUBLICATION NUMBER			DATE	TITLE				
PAGE NO.	COLM NO.	LINE NO.	NATIONAL STOCK NUMBER	REFERENCE NO.	FIGURE NO.	ITEM NO.	TOTAL NO. OF MAJOR ITEMS SUPPORTED	RECOMMENDED ACTION

PART III - REMARKS *(Any general remarks or recommendations, or suggestions for improvement of publications and blank forms. Additional blank sheets may be used if more space is needed.)*

TYPED NAME, GRADE OR TITLE	TELEPHONE EXCHANGE/AUTOVON, PLUS EXTENSION	SIGNATURE
----------------------------	--	-----------

The Metric System and Equivalents

Linear Measure

1 centimeter = 10 millimeters = .39 inch
 1 decimeter = 10 centimeters = 3.94 inches
 1 meter = 10 decimeters = 39.37 inches
 1 dekameter = 10 meters = 32.8 feet
 1 hectometer = 10 dekameters = 328.08 feet
 1 kilometer = 10 hectometers = 3,280.8 feet

Weights

1 centigram = 10 milligrams = .15 grain
 1 decigram = 10 centigrams = 1.54 grains
 1 gram = 10 decigrams = .035 ounce
 1 decagram = 10 grams = .35 ounce
 1 hectogram = 10 decagrams = 3.52 ounces
 1 kilogram = 10 hectograms = 2.2 pounds
 1 quintal = 100 kilograms = 220.46 pounds
 1 metric ton = 10 quintals = 1.1 short tons

Liquid Measure

1 centiliter = 10 milliliters = .34 fl. ounce
 1 deciliter = 10 centiliters = 3.38 fl. ounces
 1 liter = 10 deciliters = 33.81 fl. ounces
 1 dekaliter = 10 liters = 2.64 gallons
 1 hectoliter = 10 dekaliters = 26.42 gallons
 1 kiloliter = 10 hectoliters = 264.18 gallons

Square Measure

1 sq. centimeter = 100 sq. millimeters = .155 sq. inch
 1 sq. decimeter = 100 sq. centimeters = 15.5 sq. inches
 1 sq. meter (centare) = 100 sq. decimeters = 10.76 sq. feet
 1 sq. dekameter (are) = 100 sq. meters = 1,076.4 sq. feet
 1 sq. hectometer (hectare) = 100 sq. dekameters = 2.47 acres
 1 sq. kilometer = 100 sq. hectometers = .386 sq. mile

Cubic Measure

1 cu. centimeter = 1000 cu. millimeters = .06 cu. inch
 1 cu. decimeter = 1000 cu. centimeters = 61.02 cu. inches
 1 cu. meter = 1000 cu. decimeters = 35.31 cu. feet

Approximate Conversion Factors

To change	To	Multiply by	To change	To	Multiply by
inches	centimeters	2.540	ounce-inches	Newton-meters	.007062
feet	meters	.305	centimeters	inches	.394
yards	meters	.914	meters	feet	3.280
miles	kilometers	1.609	meters	yards	1.094
square inches	square centimeters	6.451	kilometers	miles	.621
square feet	square meters	.093	square centimeters	square inches	.155
square yards	square meters	.836	square meters	square feet	10.764
square miles	square kilometers	2.590	square meters	square yards	1.196
acres	square hectometers	.405	square kilometers	square miles	.386
cubic feet	cubic meters	.028	square hectometers	acres	2.471
cubic yards	cubic meters	.765	cubic meters	cubic feet	35.315
fluid ounces	milliliters	29.573	cubic meters	cubic yards	1.308
pints	liters	.473	milliliters	fluid ounces	.034
quarts	liters	.946	liters	pints	2.113
gallons	liters	3.785	liters	quarts	1.057
ounces	grams	28.349	liters	gallons	.264
pounds	kilograms	.454	grams	ounces	.035
short tons	metric tons	.907	kilograms	pounds	2.205
pound-feet	Newton-meters	1.356	metric tons	short tons	1.102
pound-inches	Newton-meters	.11296			

Temperature (Exact)

°F	Fahrenheit temperature	5/9 (after subtracting 32)	Celsius temperature	°C
----	------------------------	----------------------------	---------------------	----

PIN: 074618